



EVOTECH®
P E R F O R M A N C E

www.evotech-performance.com

Suzuki GSX-S 1000 GT

Tail Tidy



Kit Contents

- Ⓐ 1 x Retro Light
- Ⓑ 1 x Connector 10
- Ⓒ 2 x M4 Flange Nut
- Ⓓ 2 x No 2 P-clip
- Ⓔ 2 x M4 x 5mm Black Button Bolts
- Ⓕ 2 x M5 x 12mm Black Button Bolts
- Ⓖ 4 x M6 x 16mm Black Button Bolts
- Ⓗ 4 x Rubber Spacer

EVER PERFORMANCE[®]

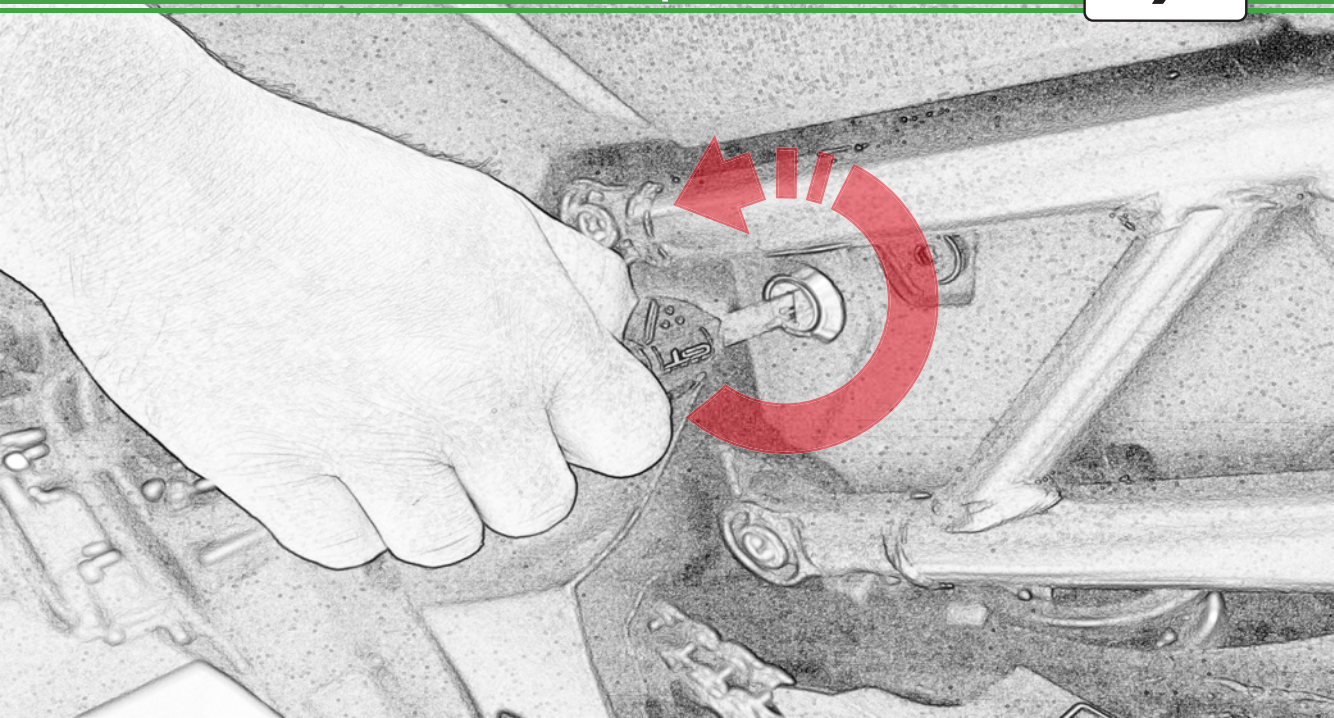

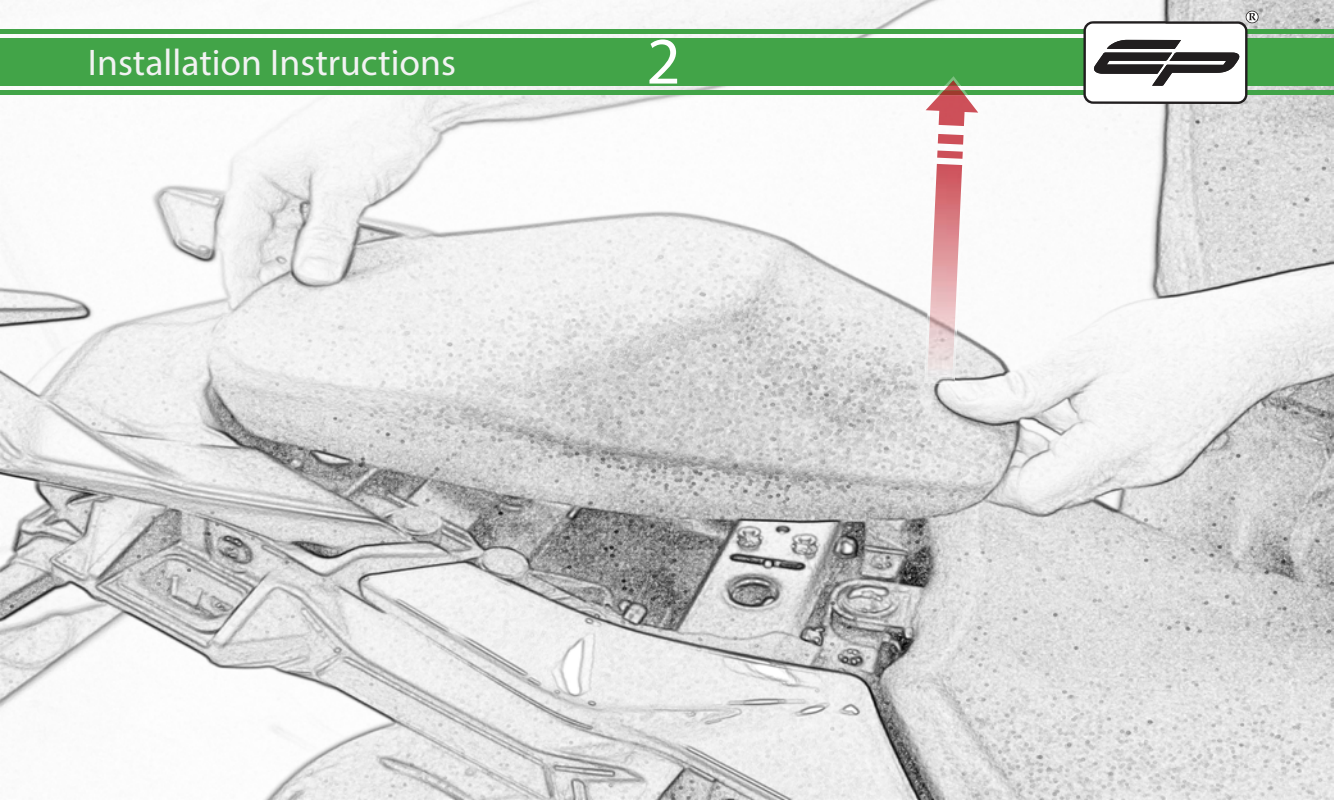

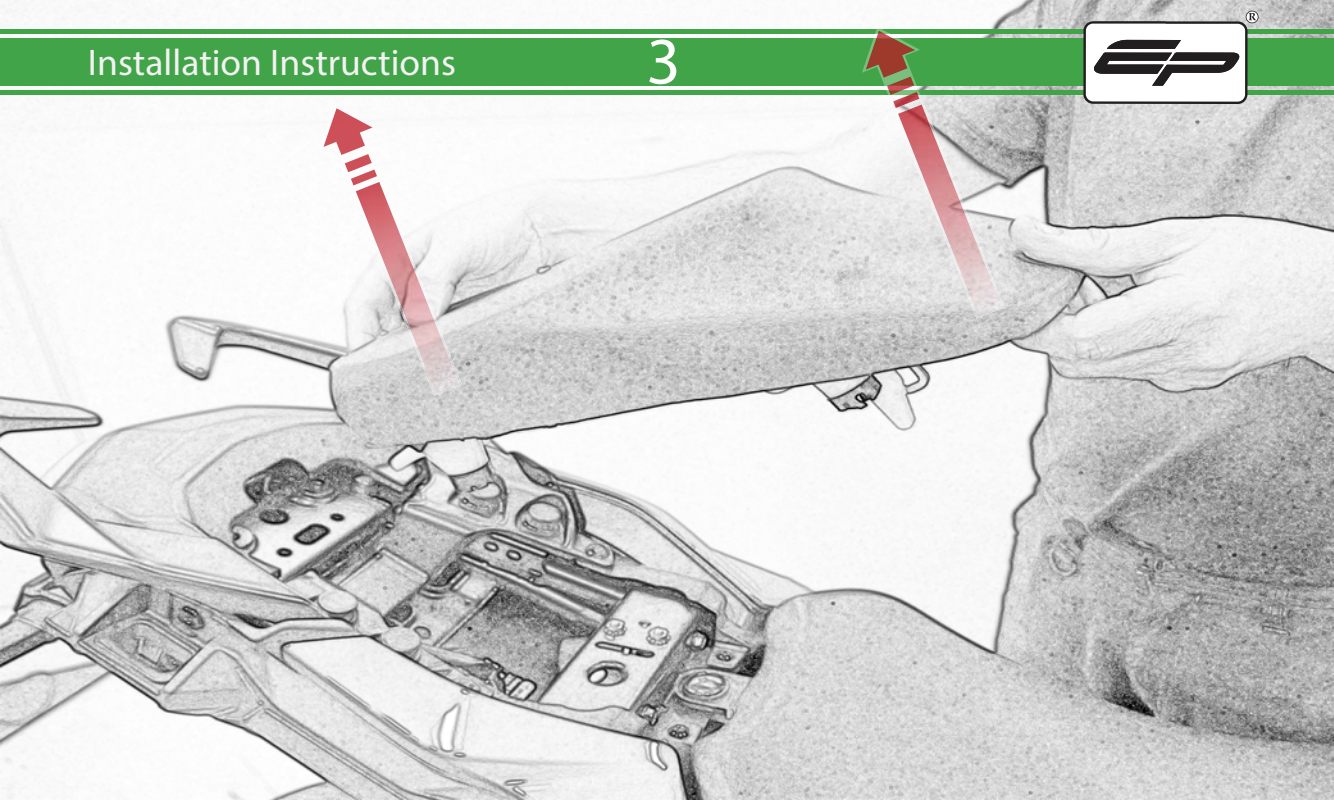

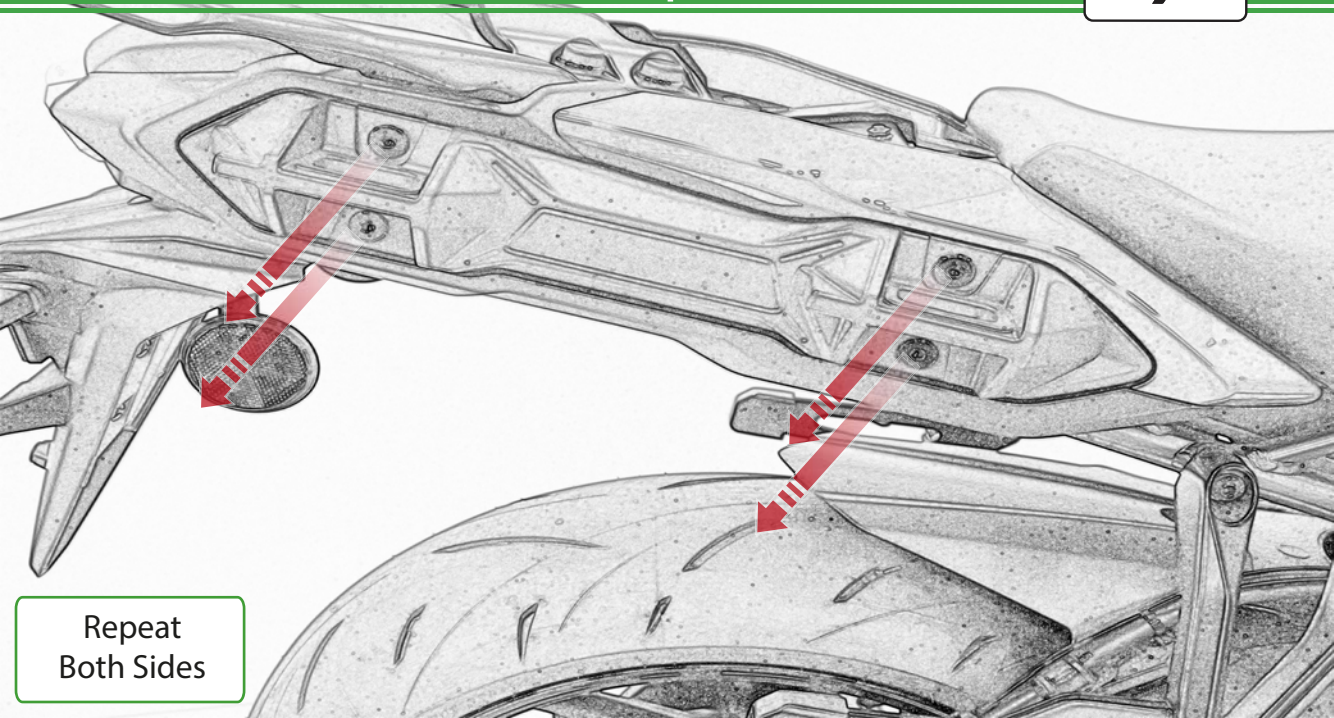

Repeat
Both Sides

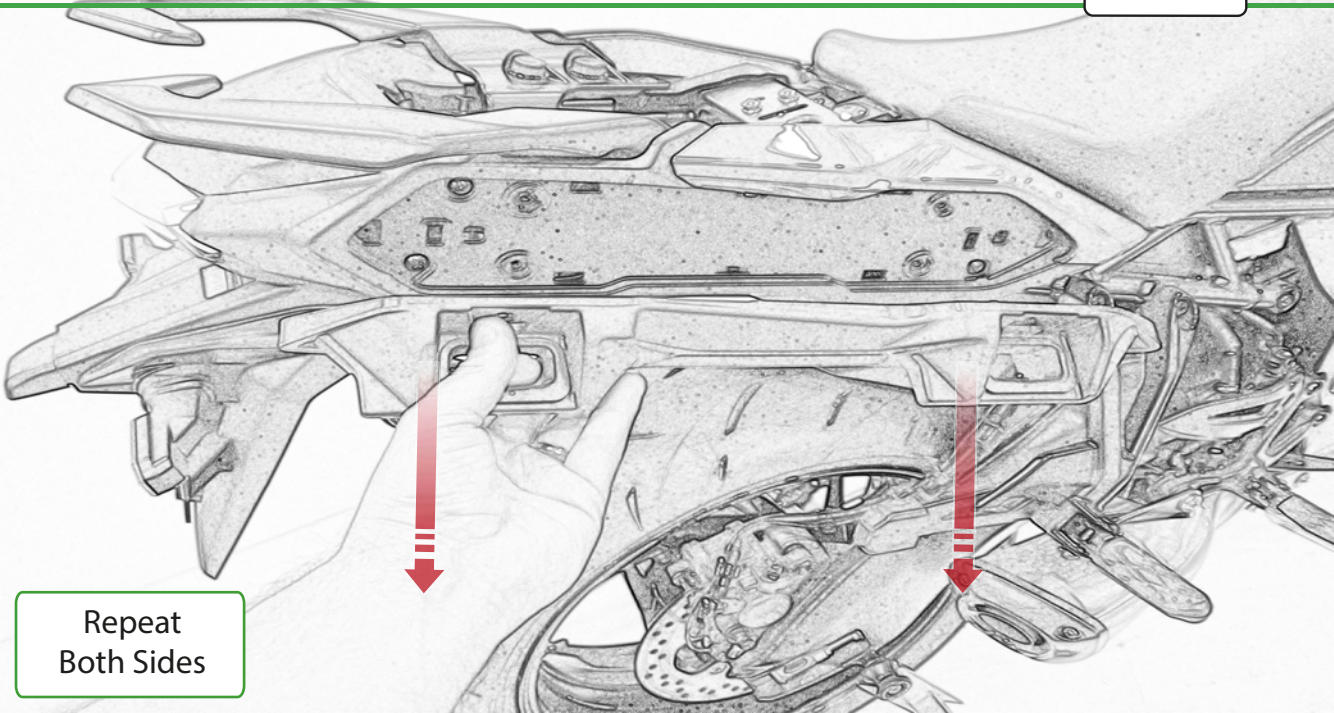

Repeat
Both Sides

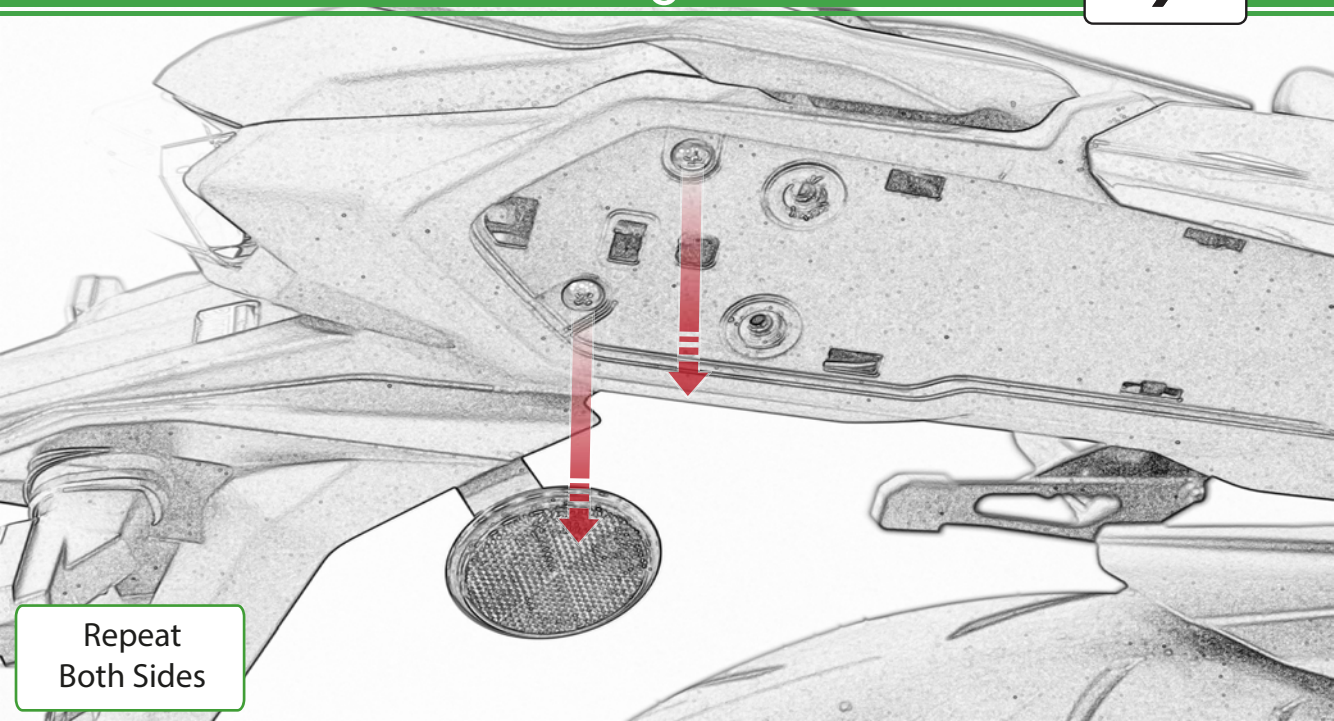

Repeat
Both Sides

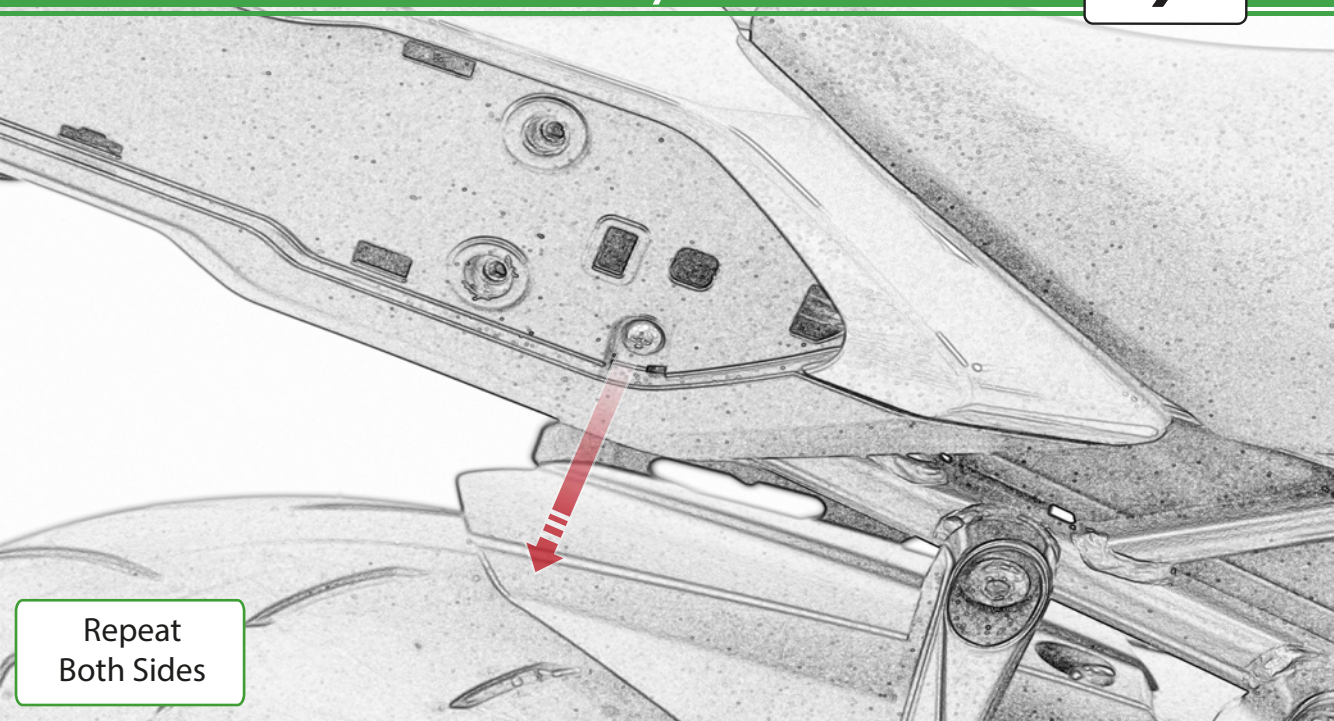

Repeat
Both Sides

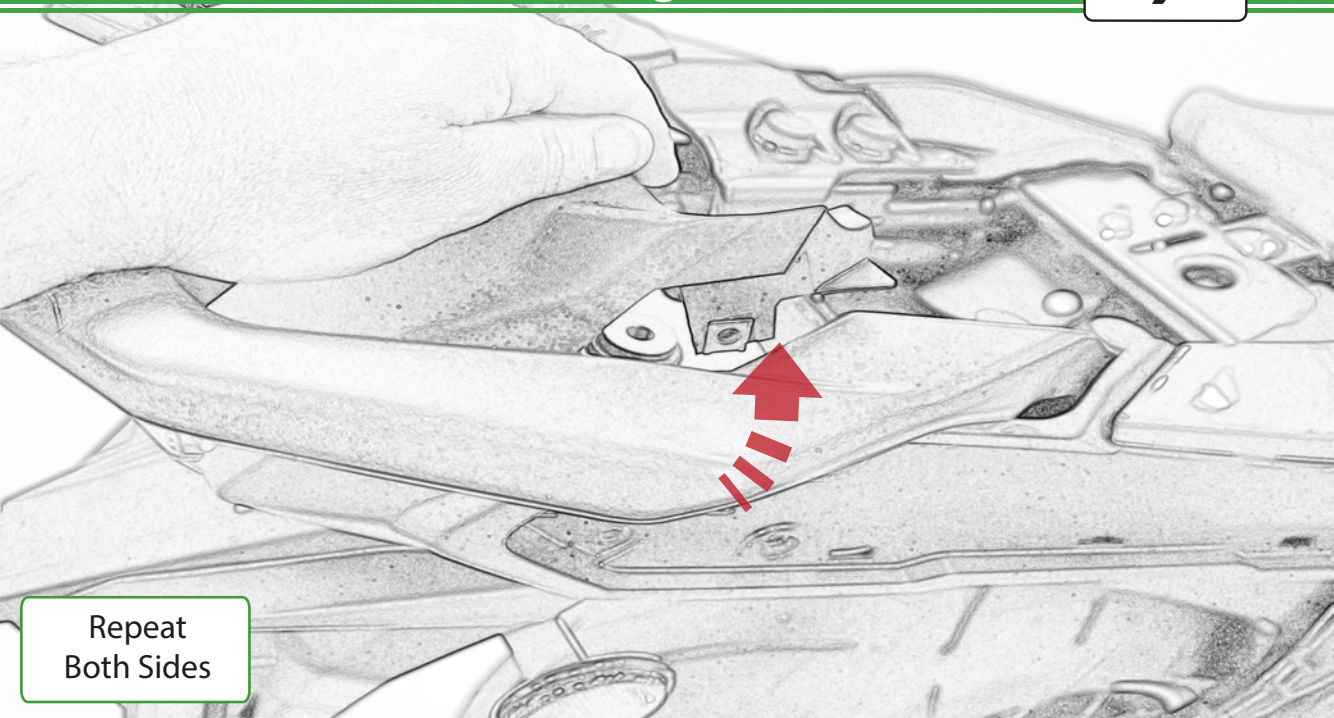

Repeat
Both Sides

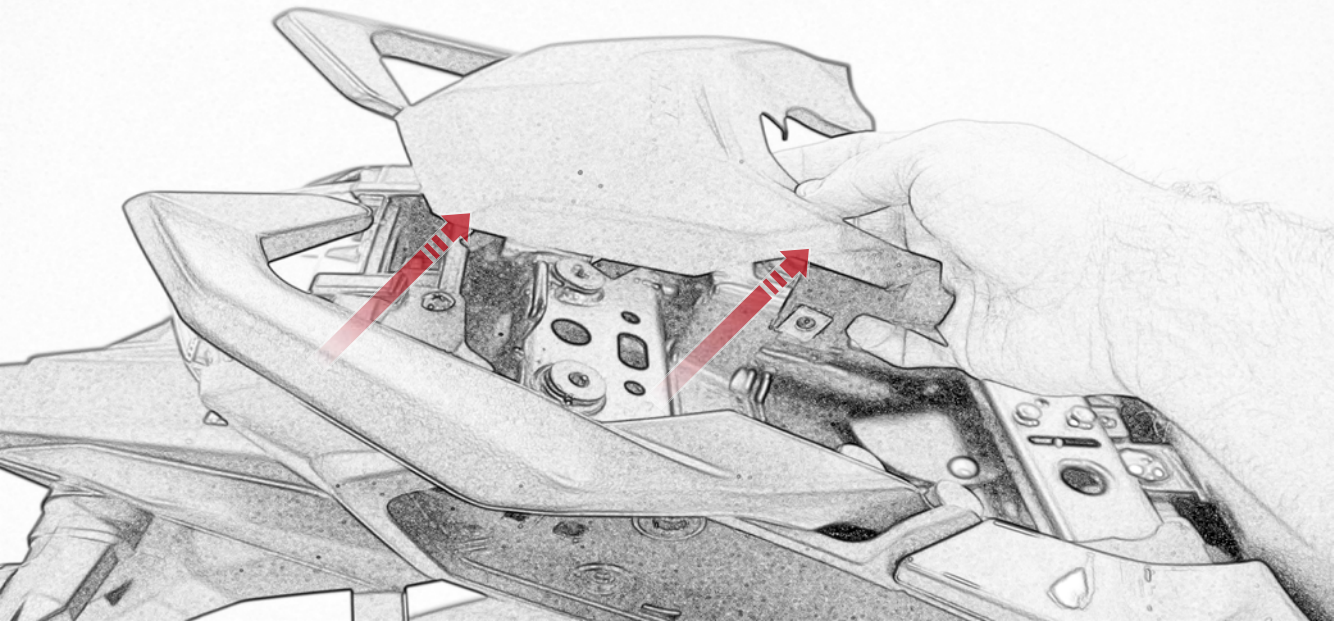

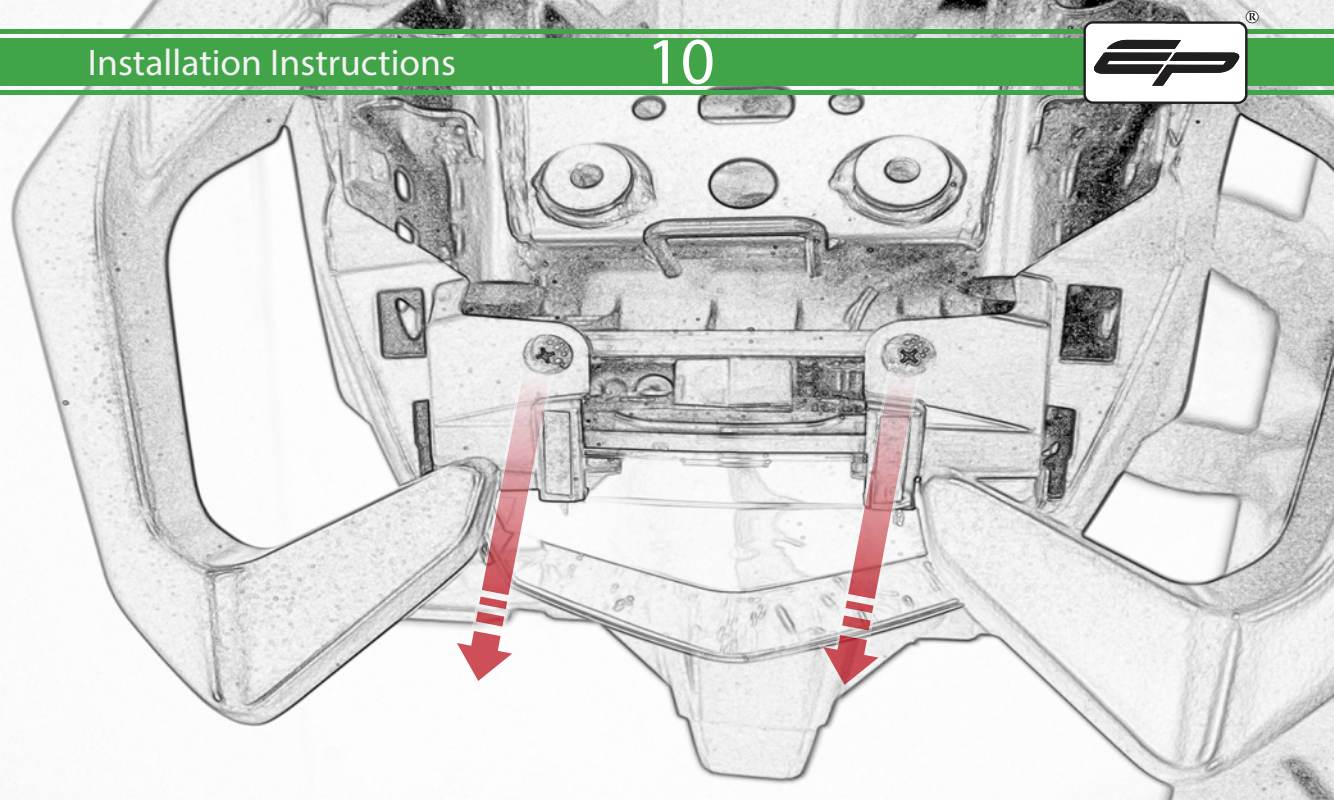

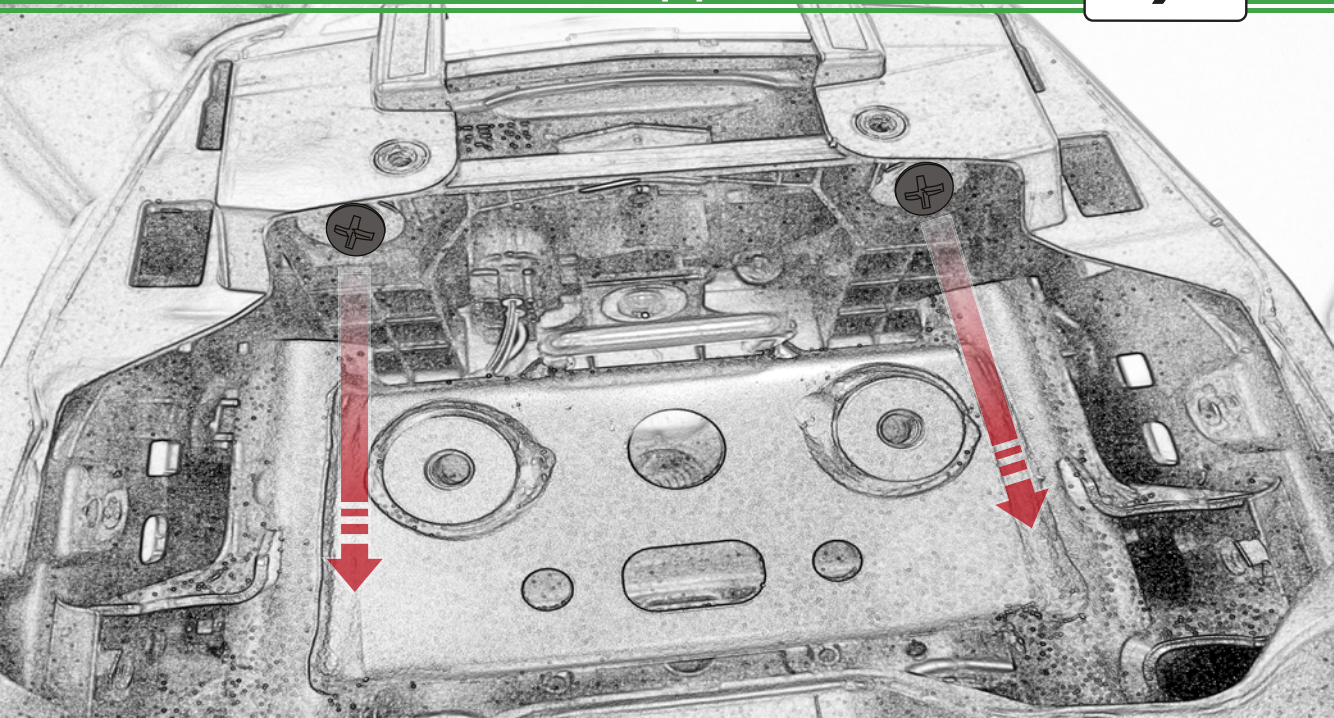

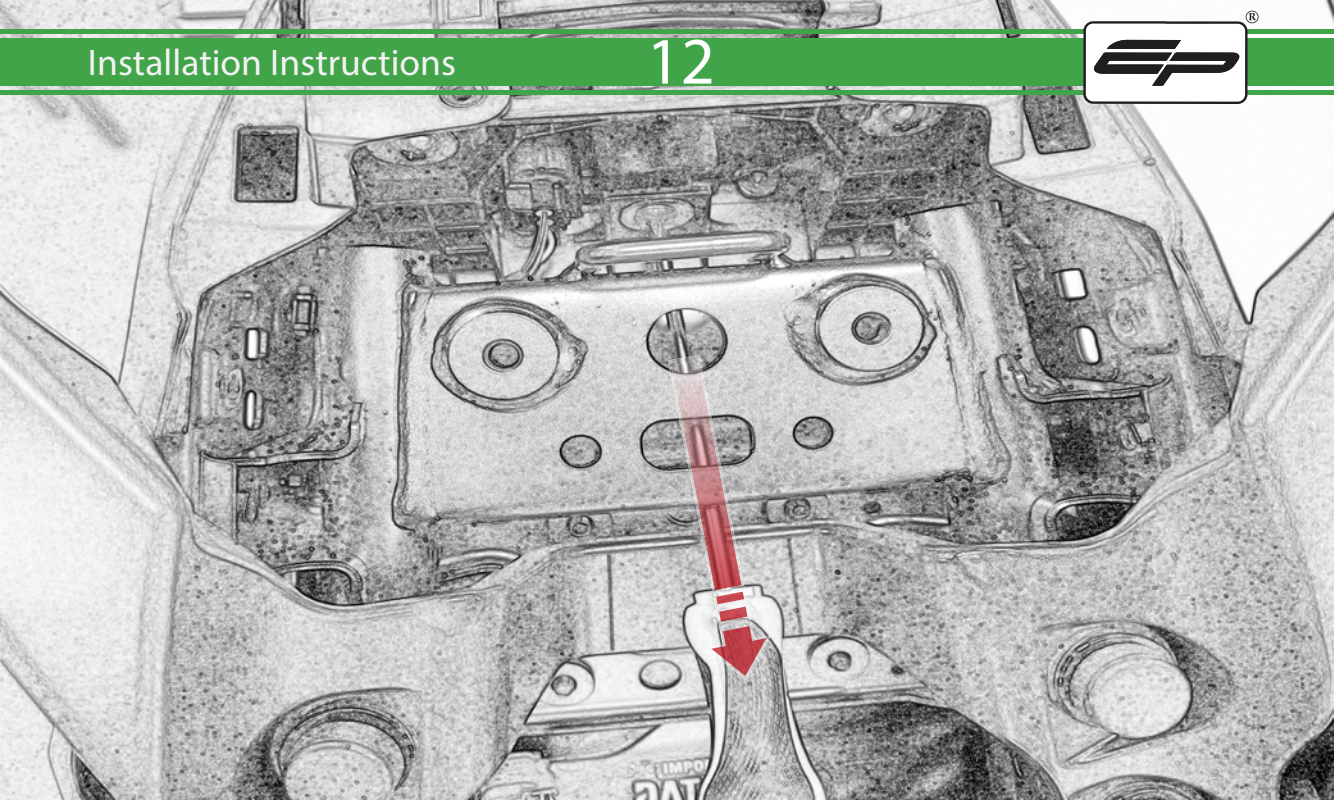

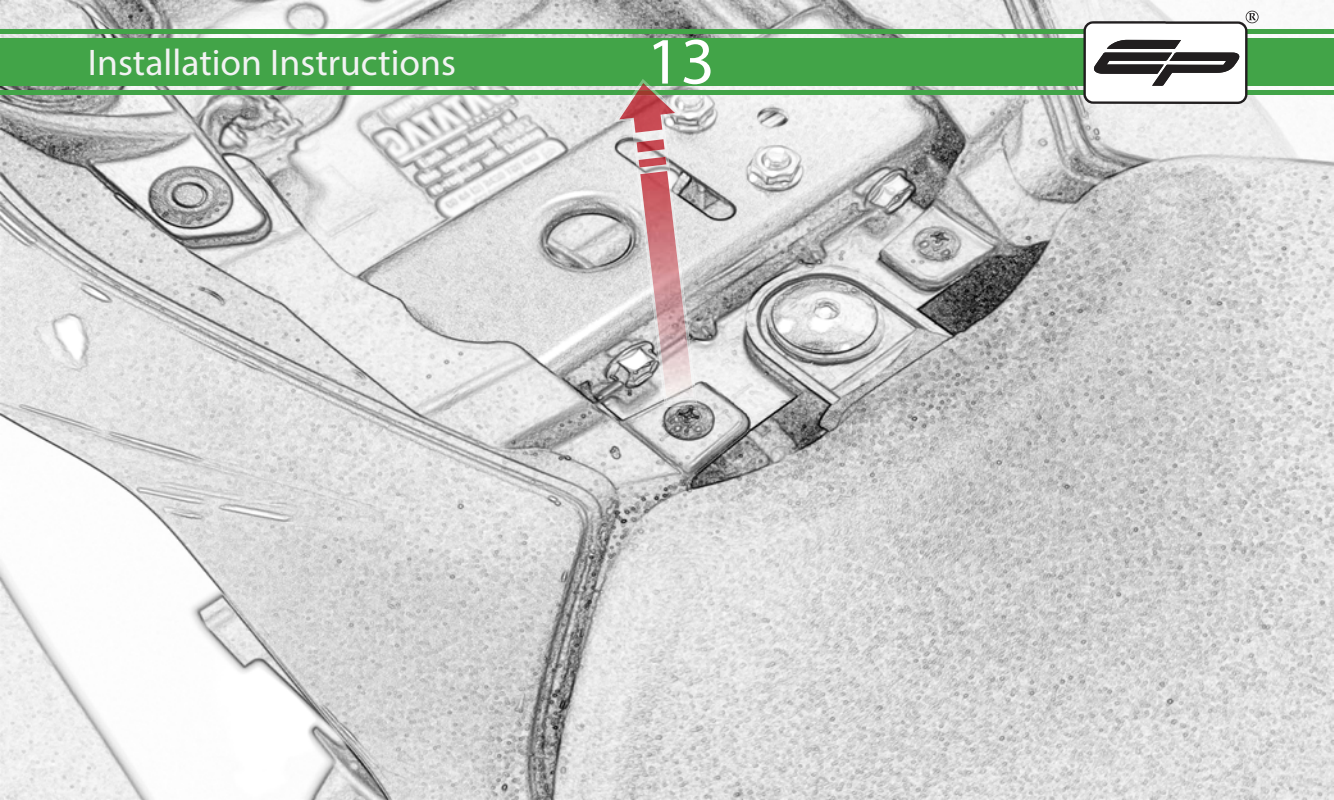



RELEASE

RE-SET

RE-FIT

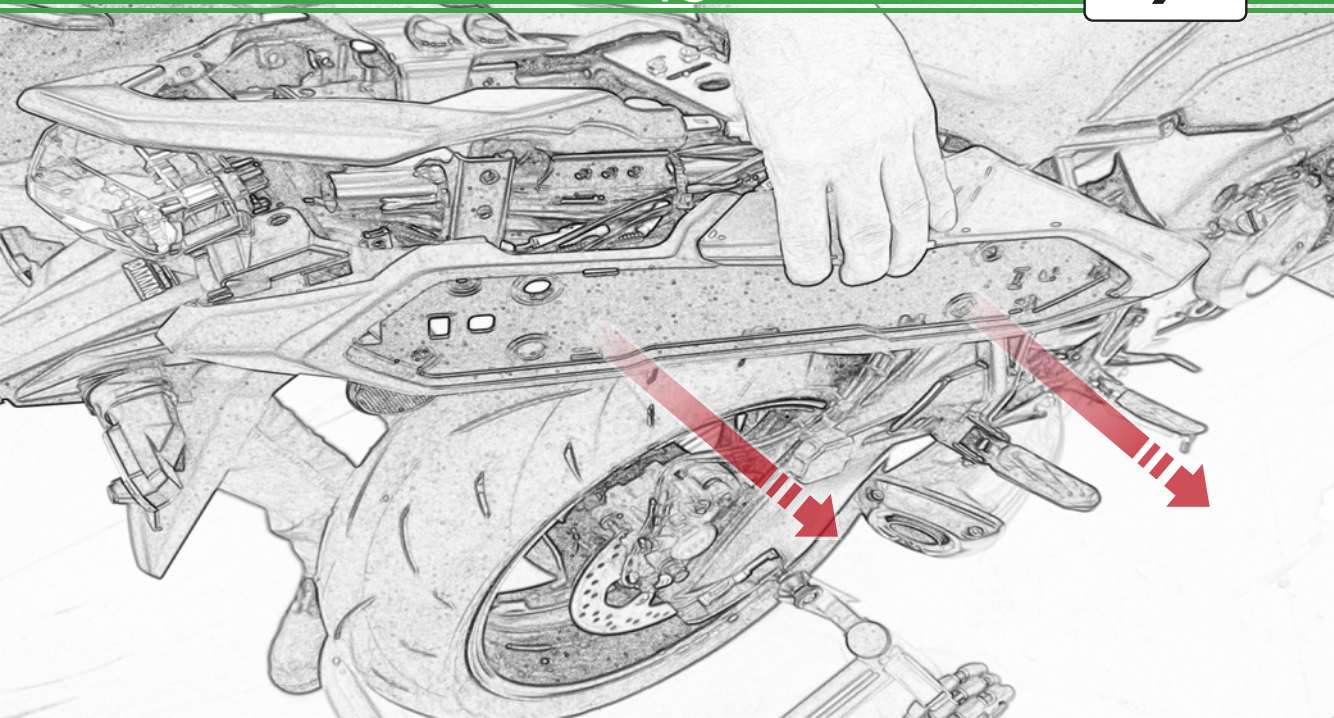

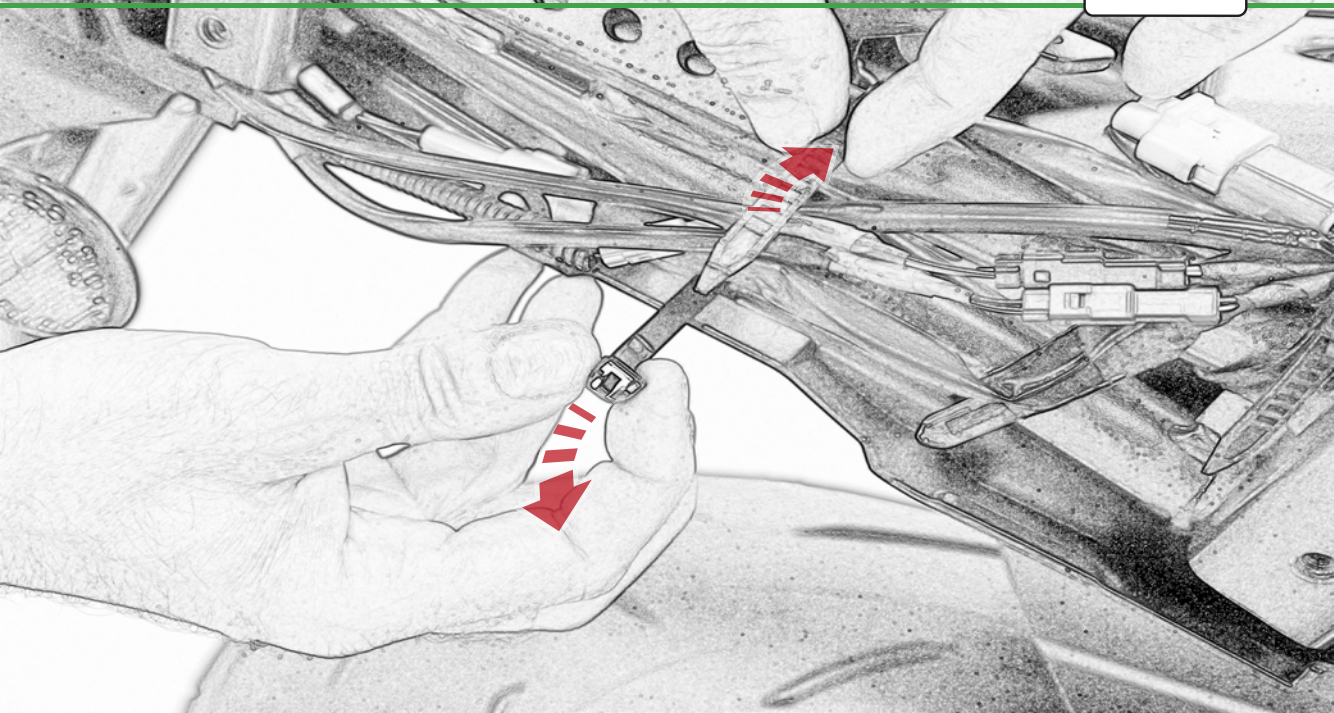

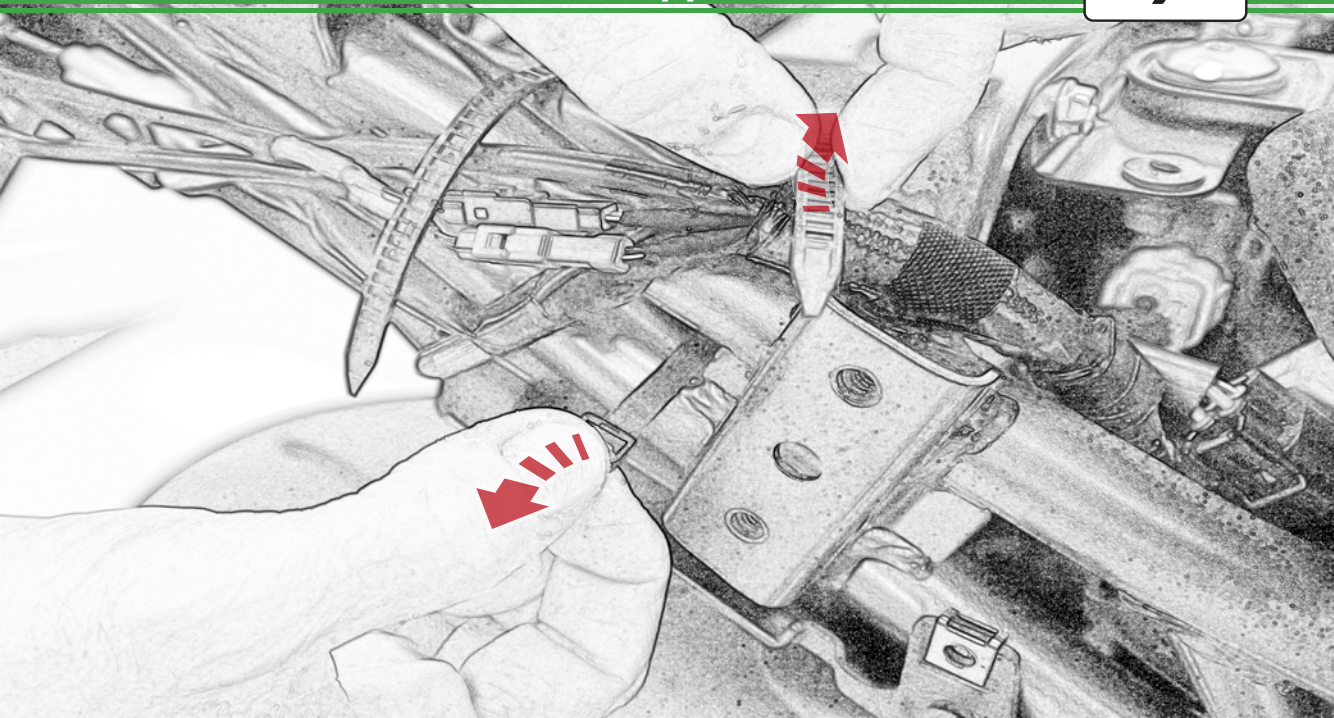

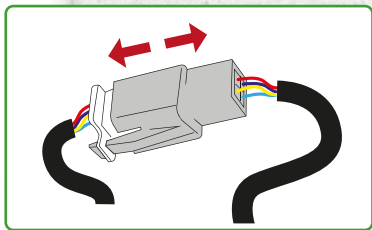
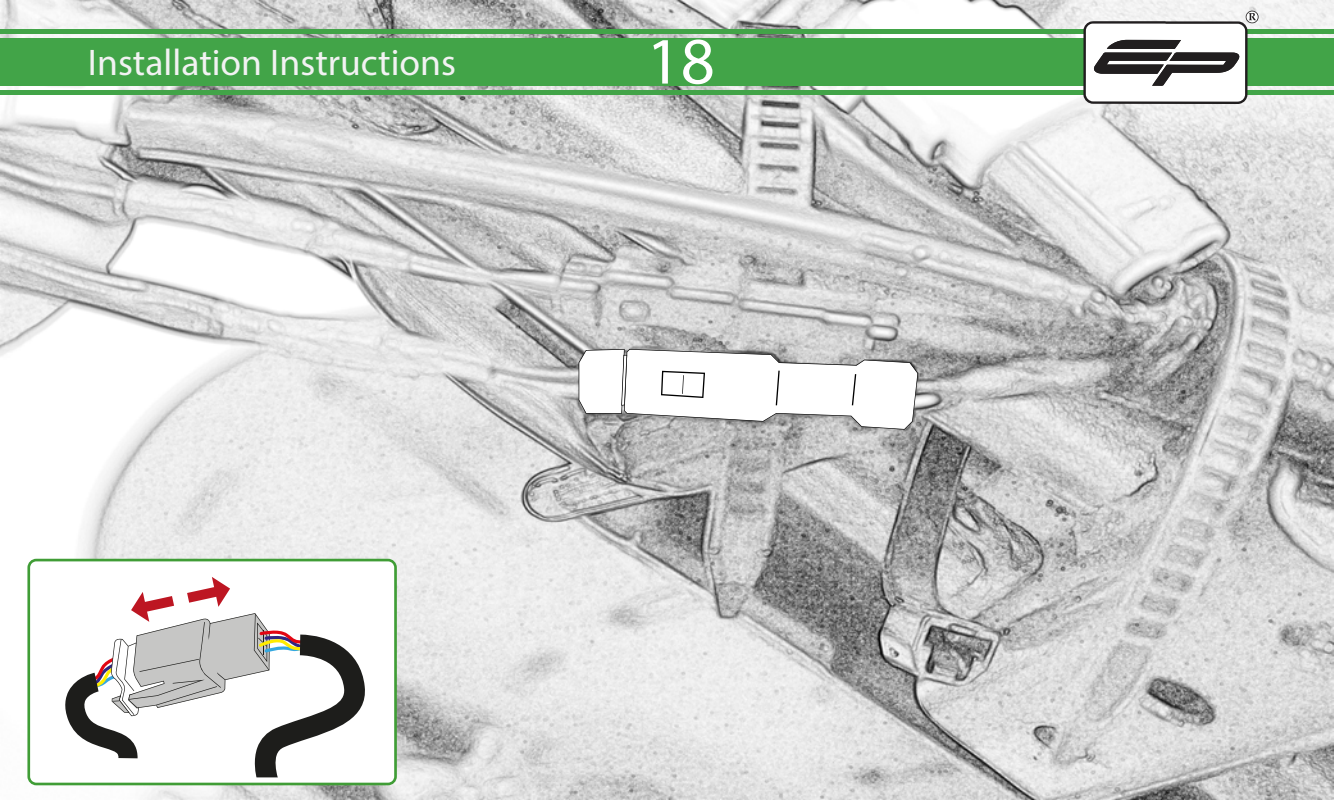

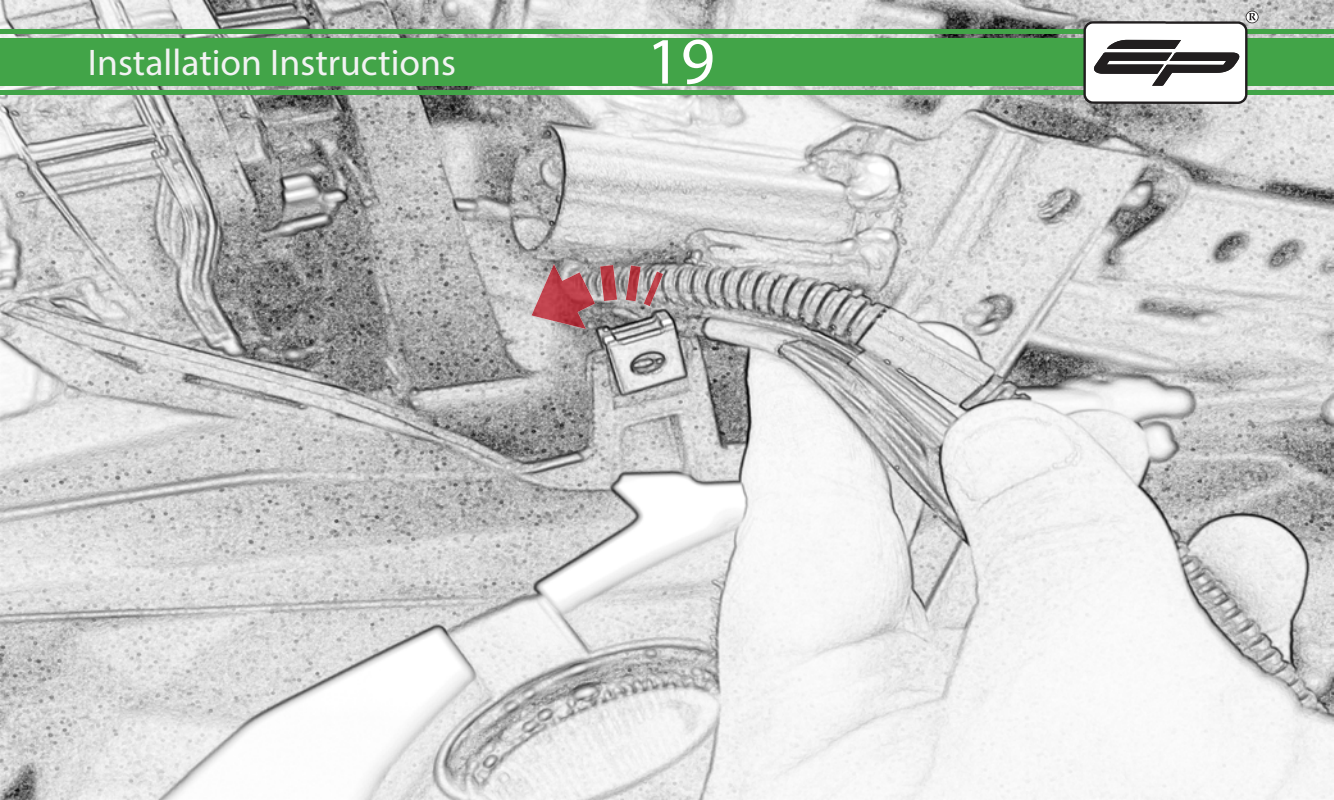

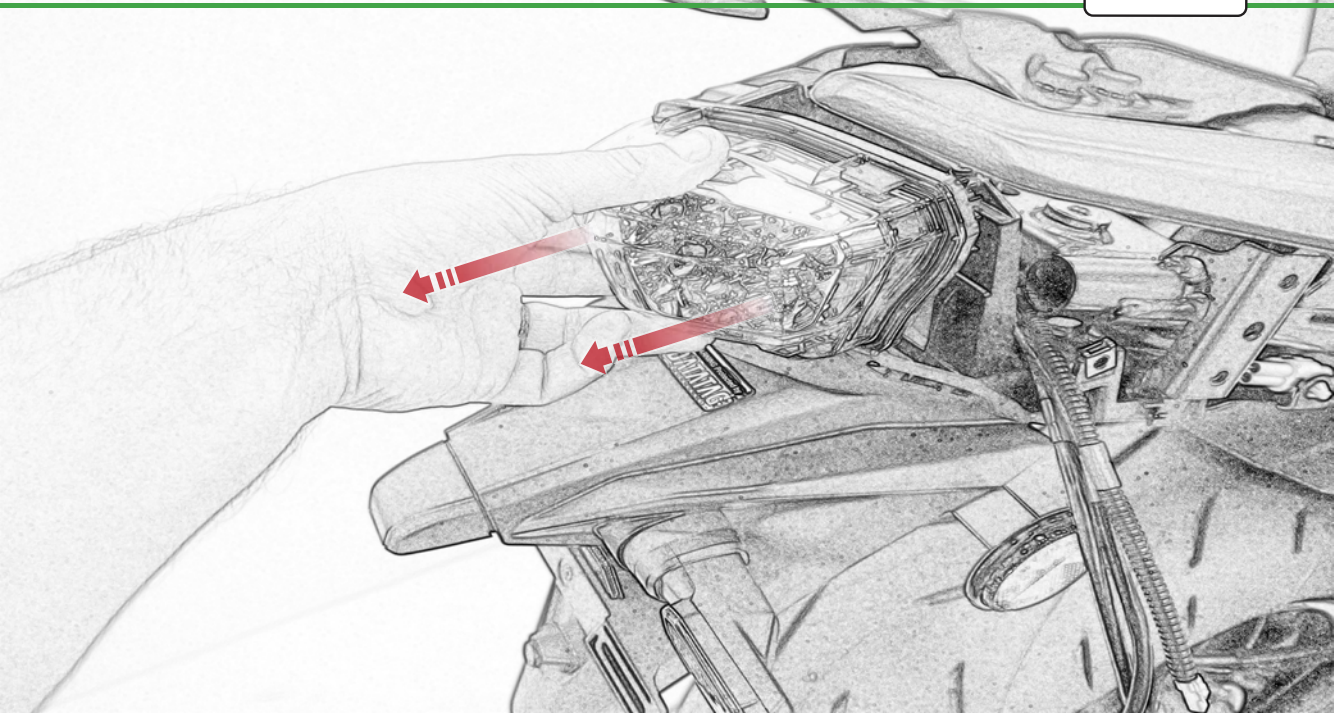

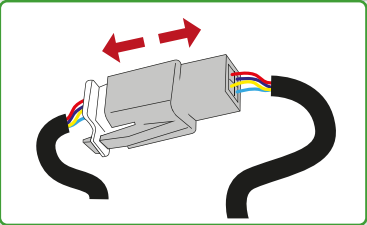
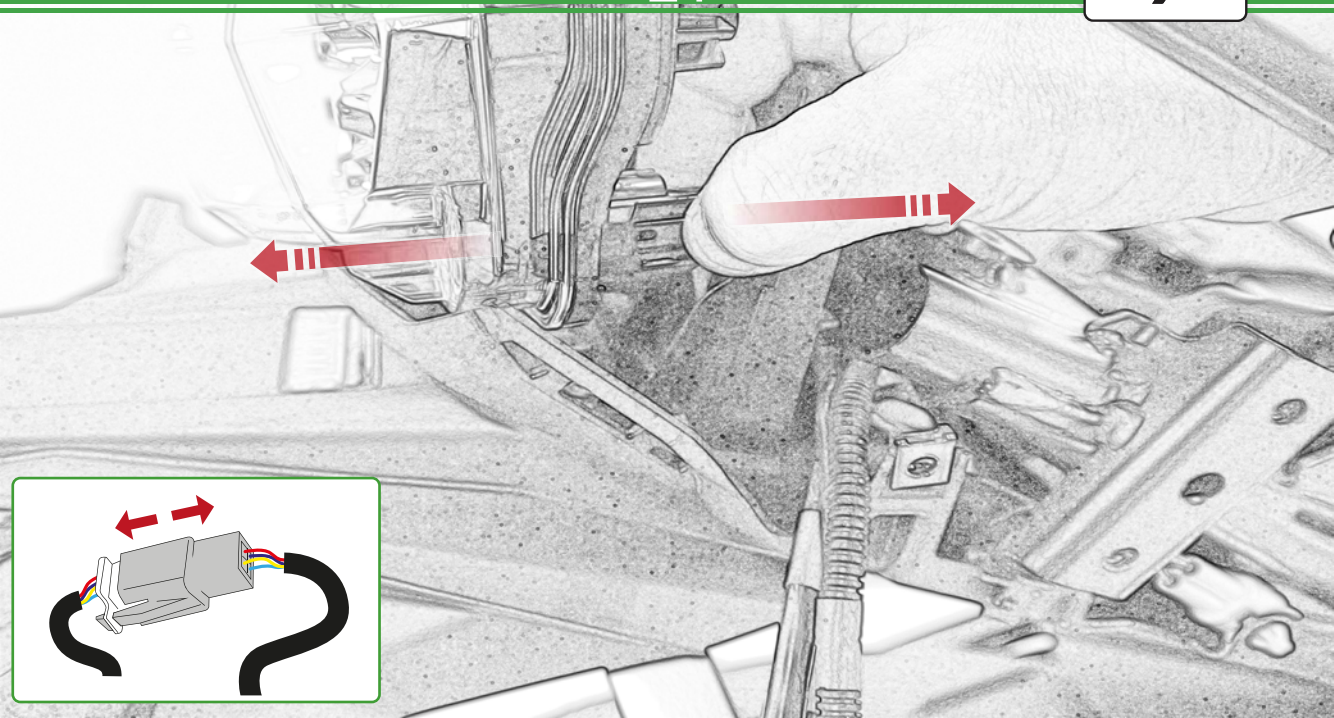

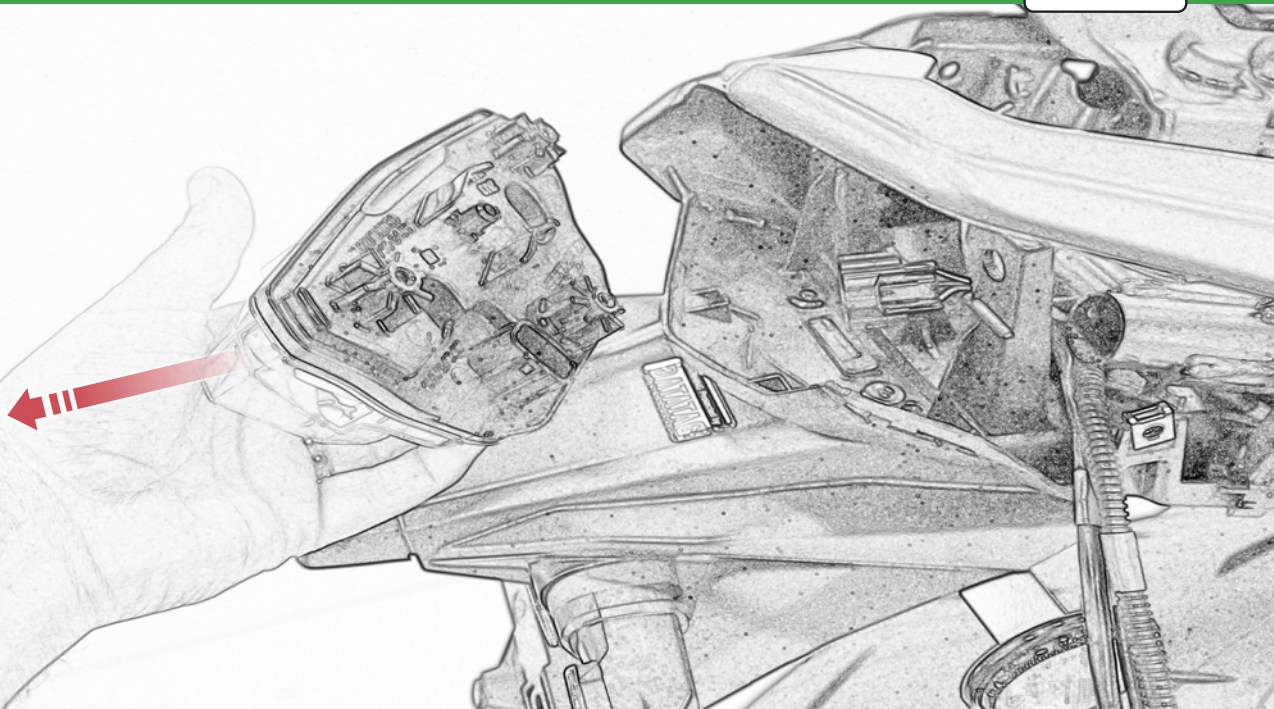

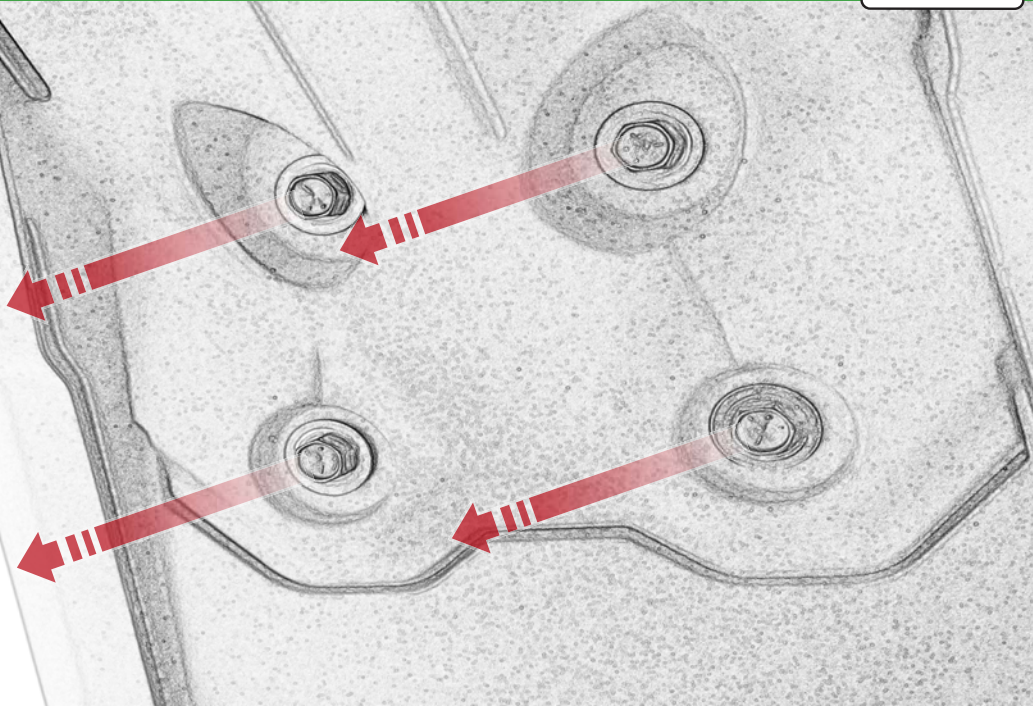

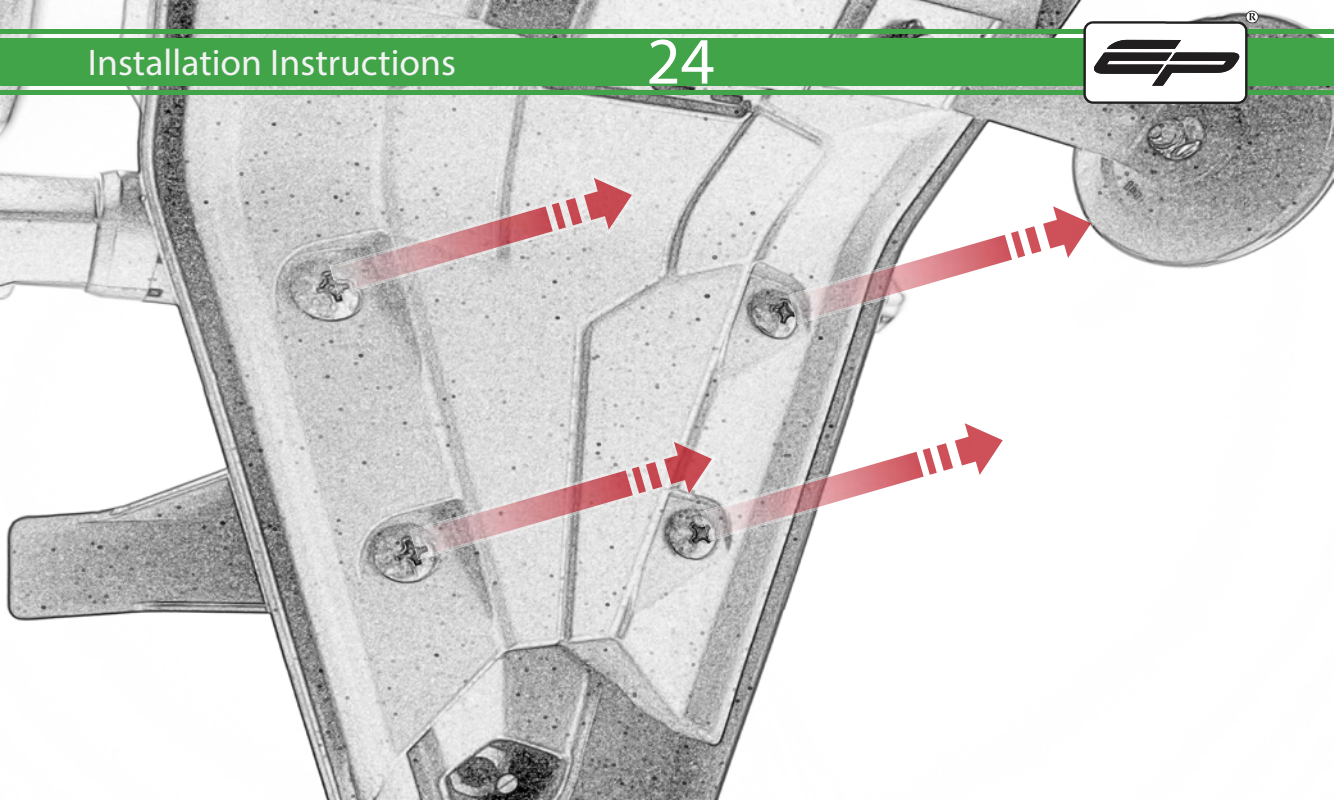

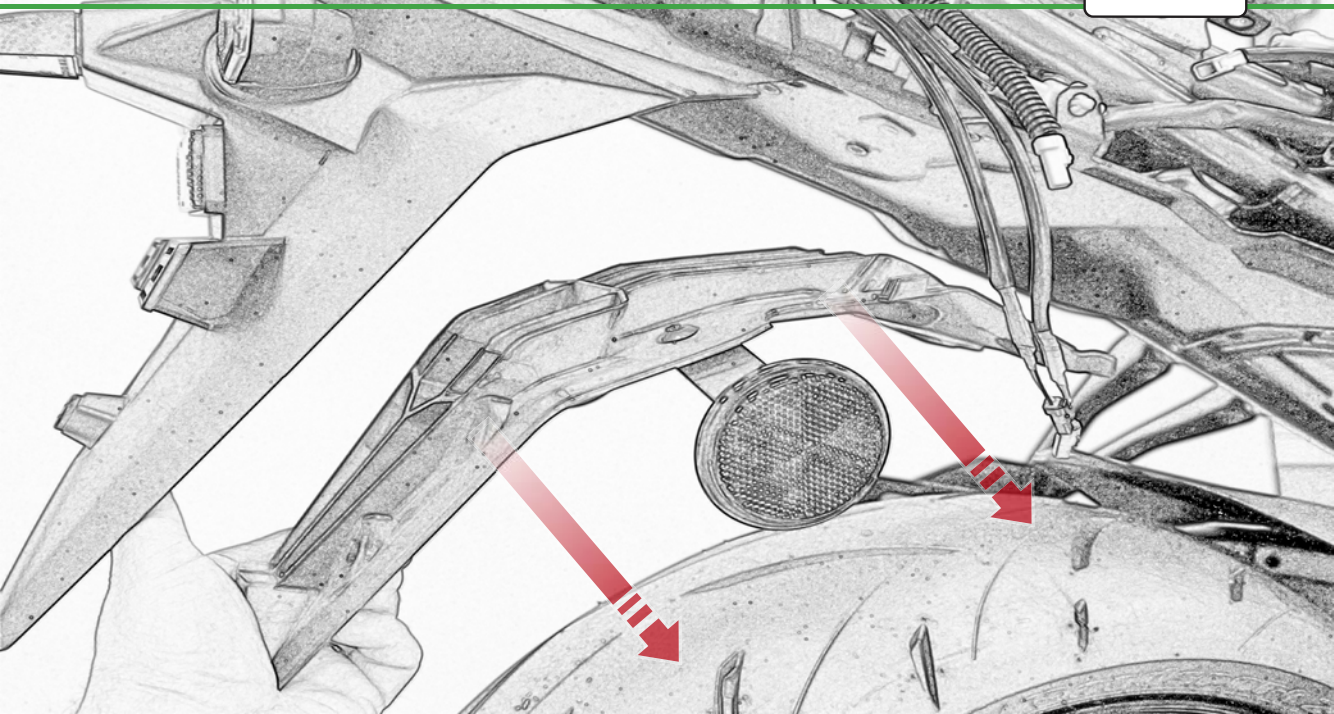

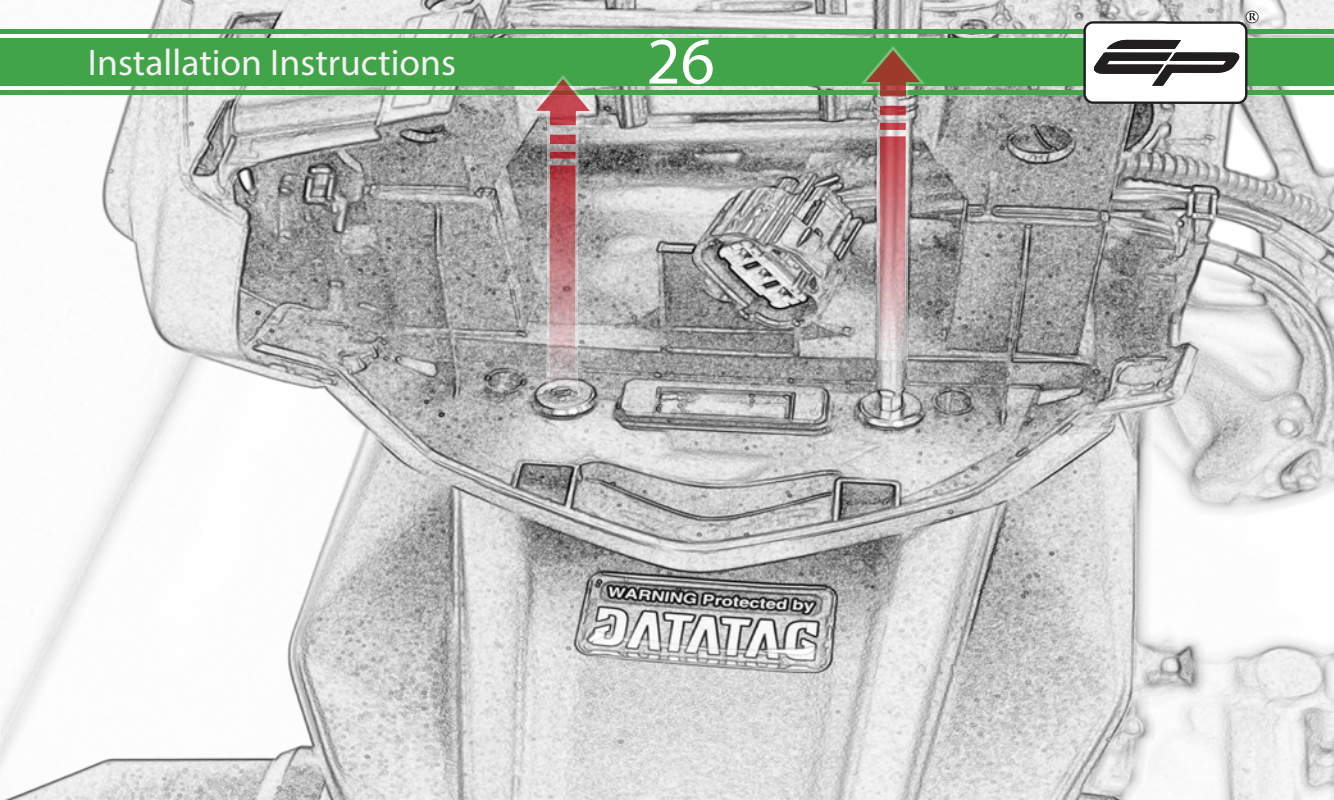

WARNING Protected by
DATATAG

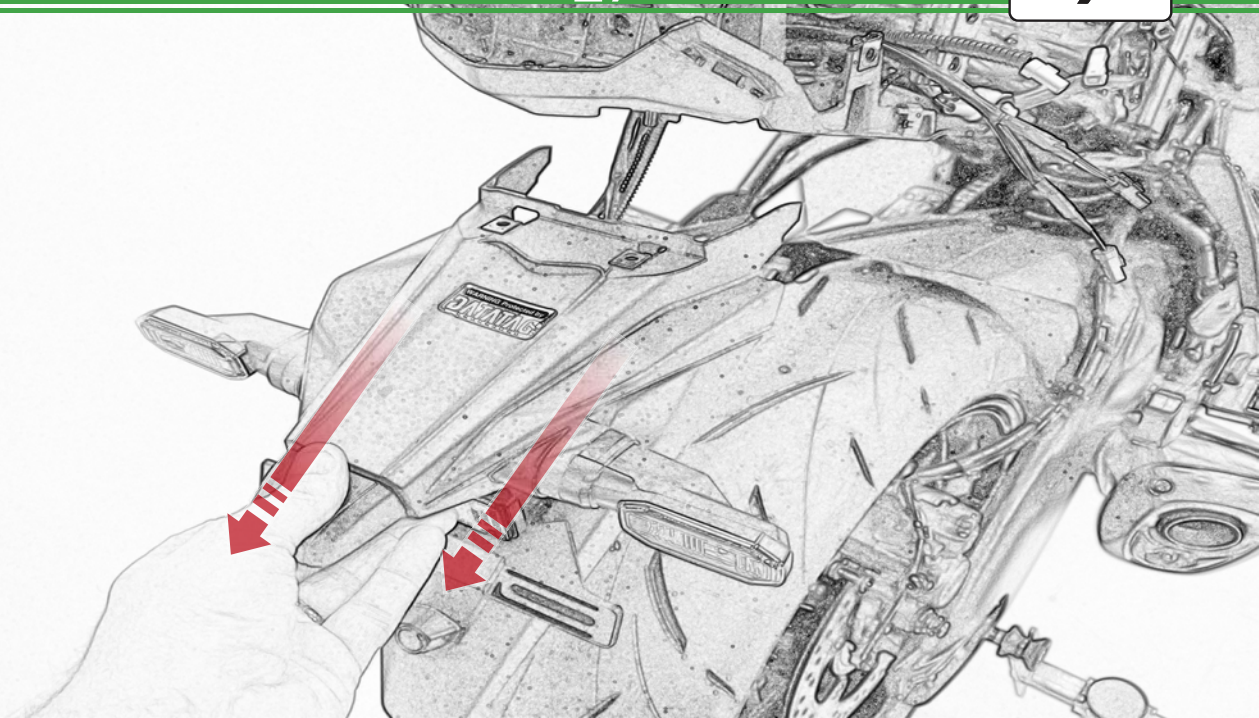

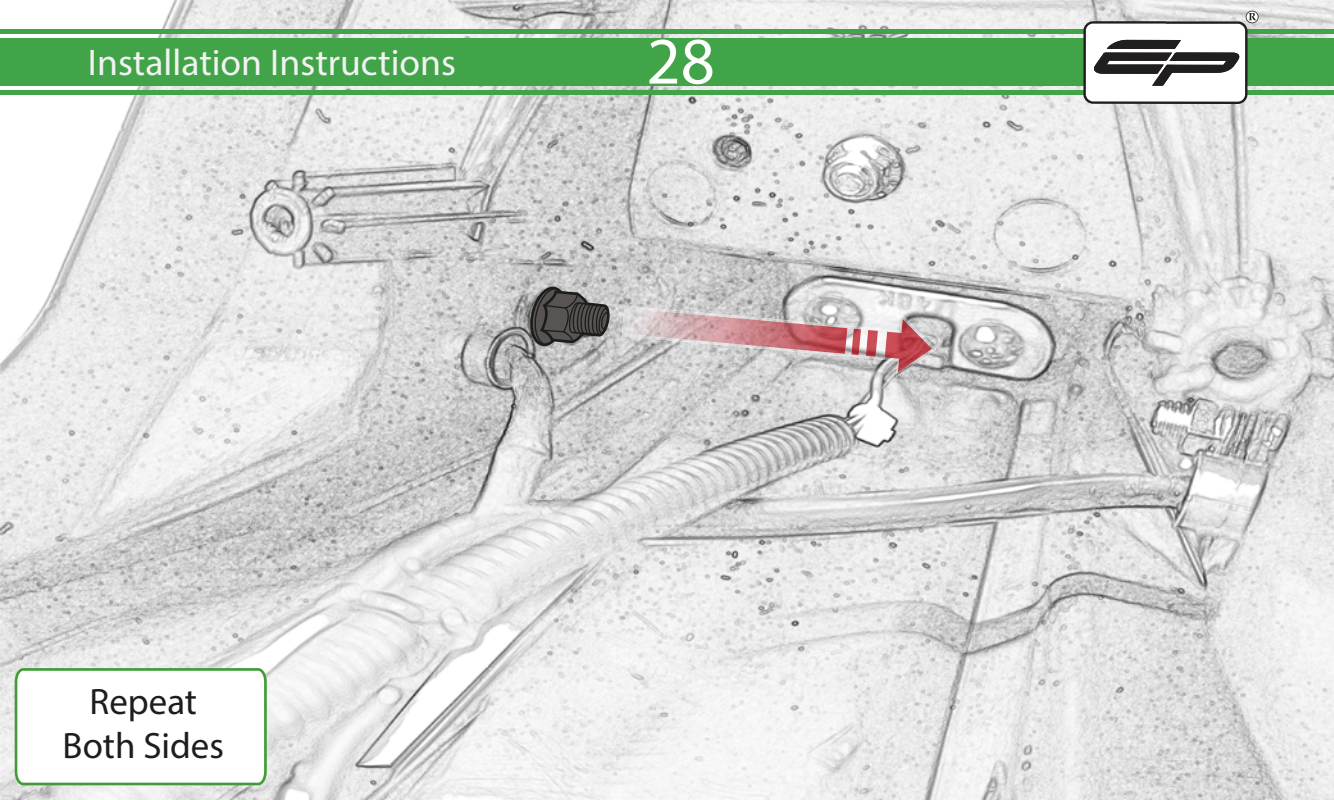

Repeat
Both Sides

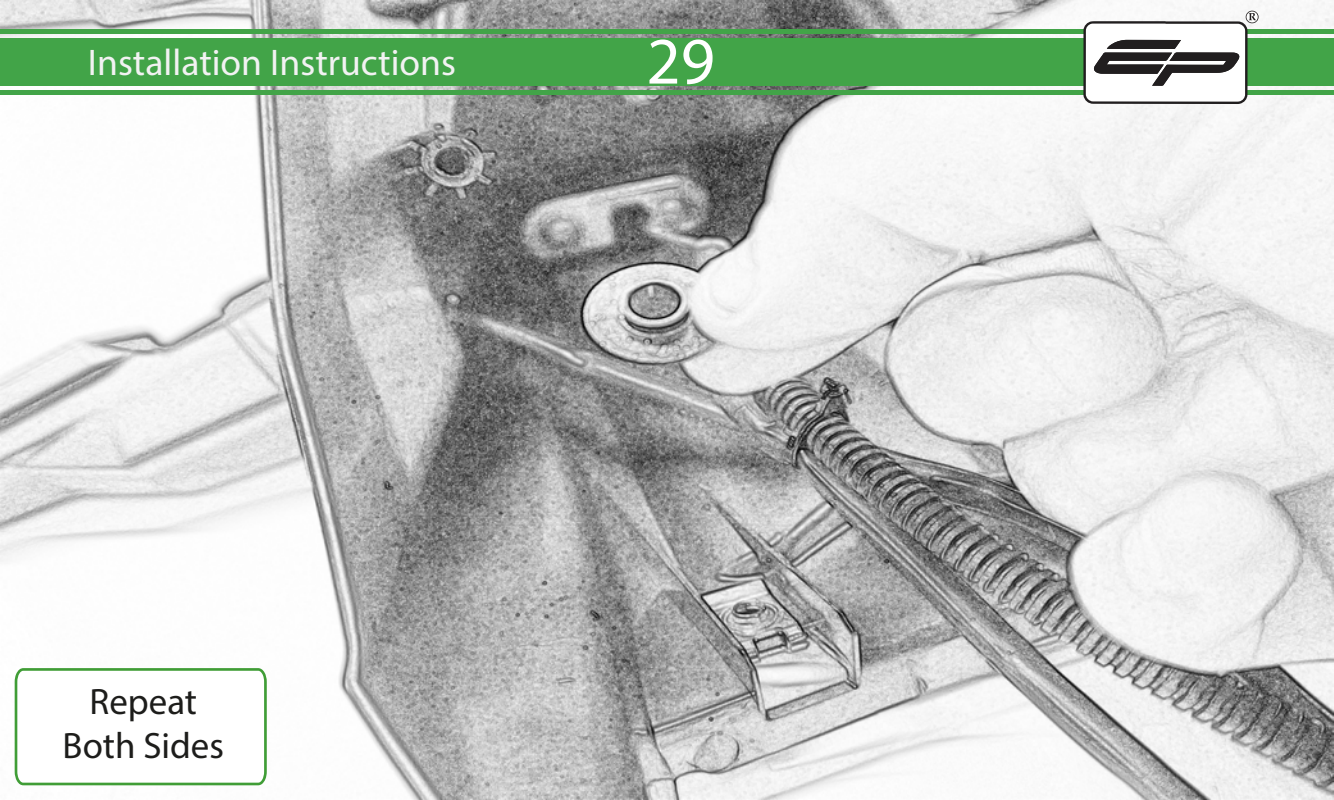

Repeat
Both Sides

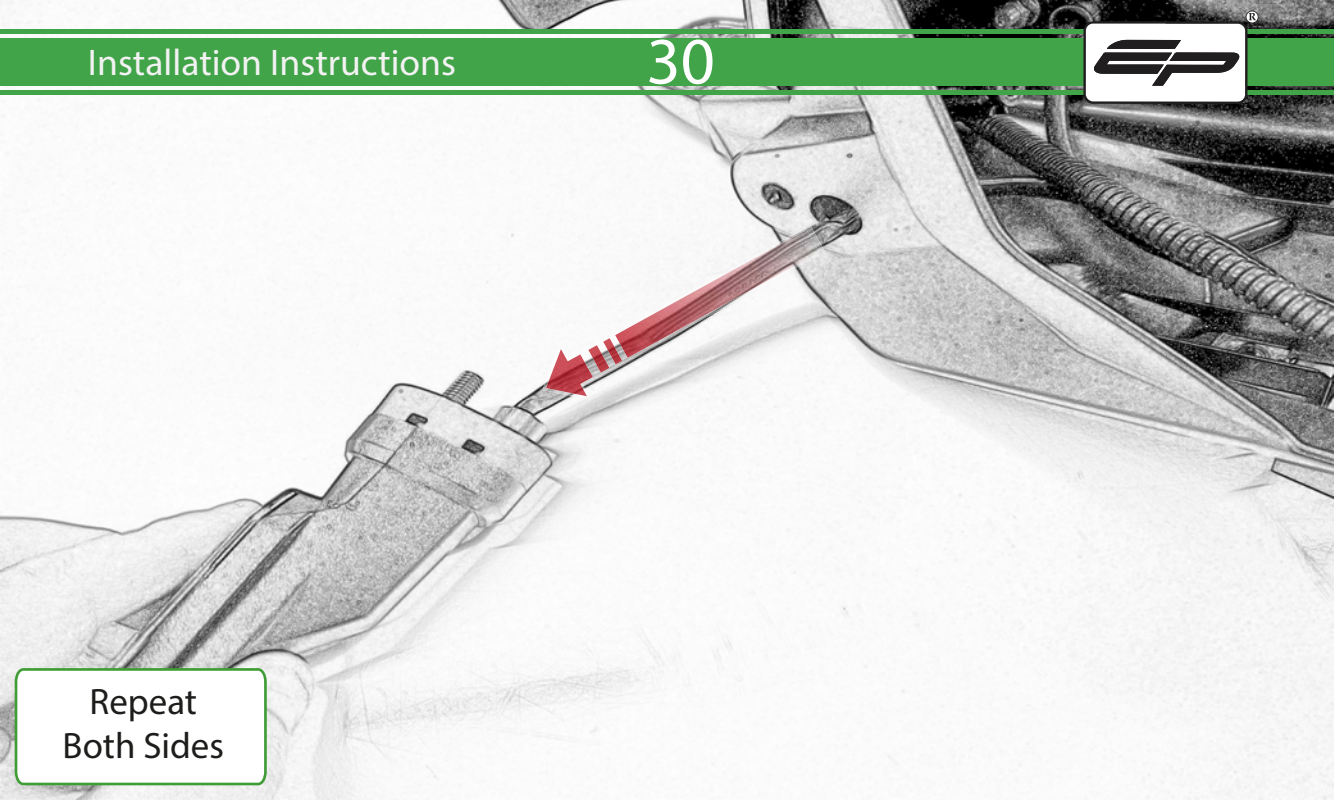

Repeat
Both Sides

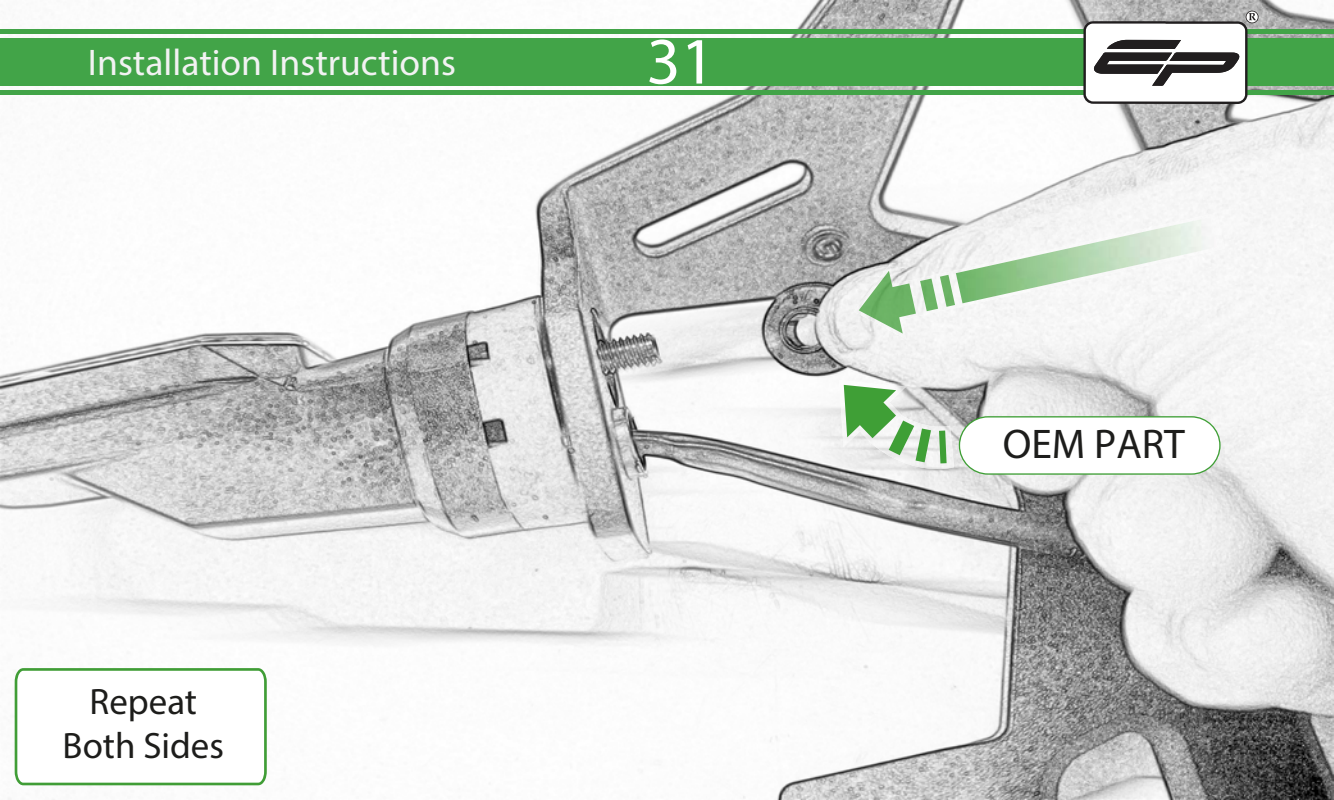

OEM PART

Repeat
Both Sides

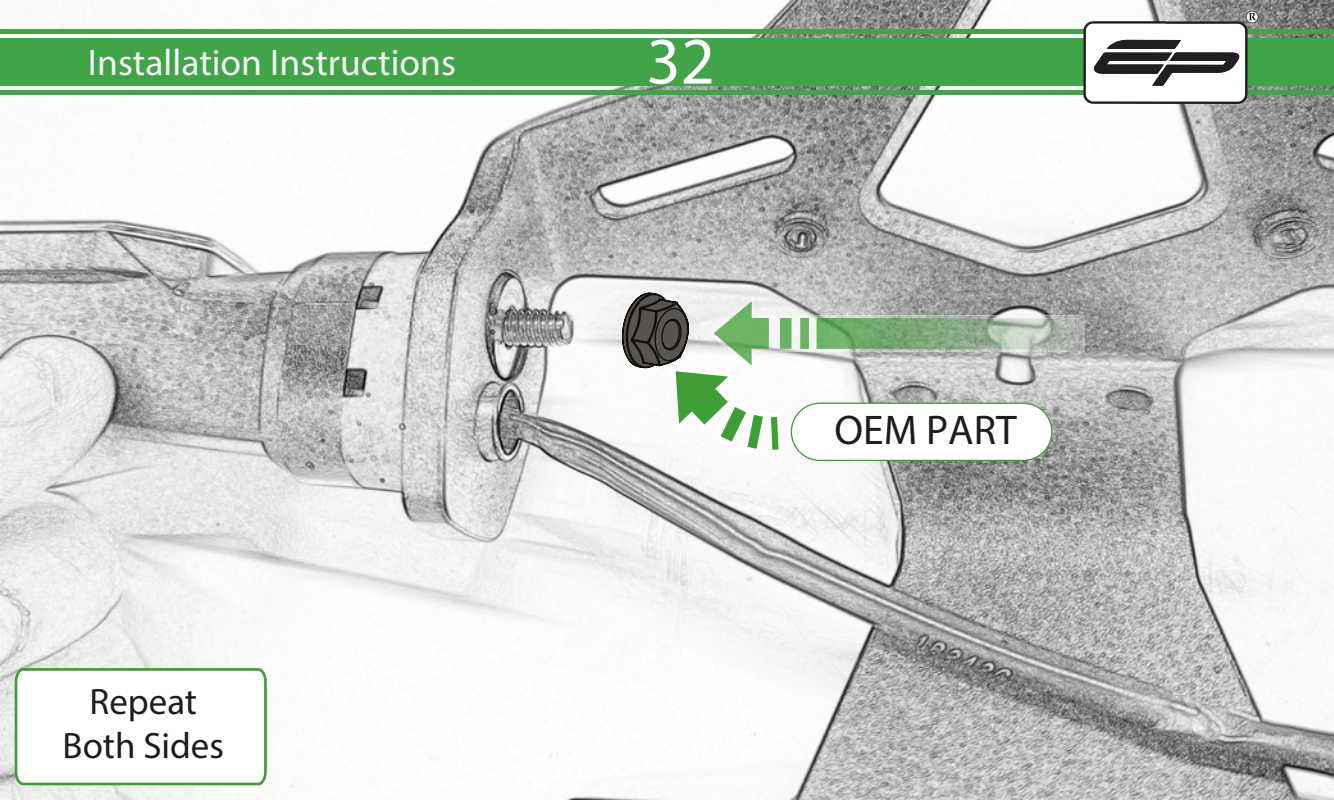

OEM PART

Repeat
Both Sides

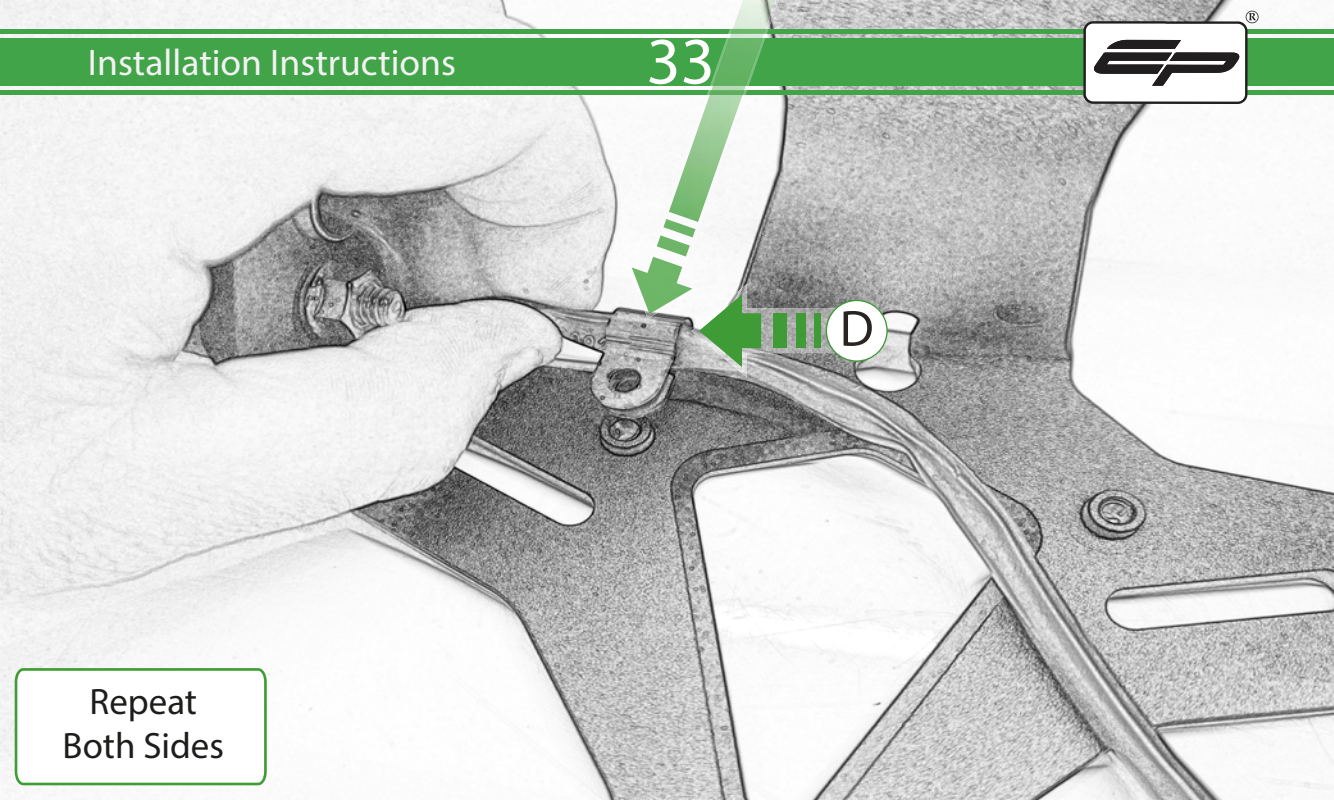

Repeat
Both Sides

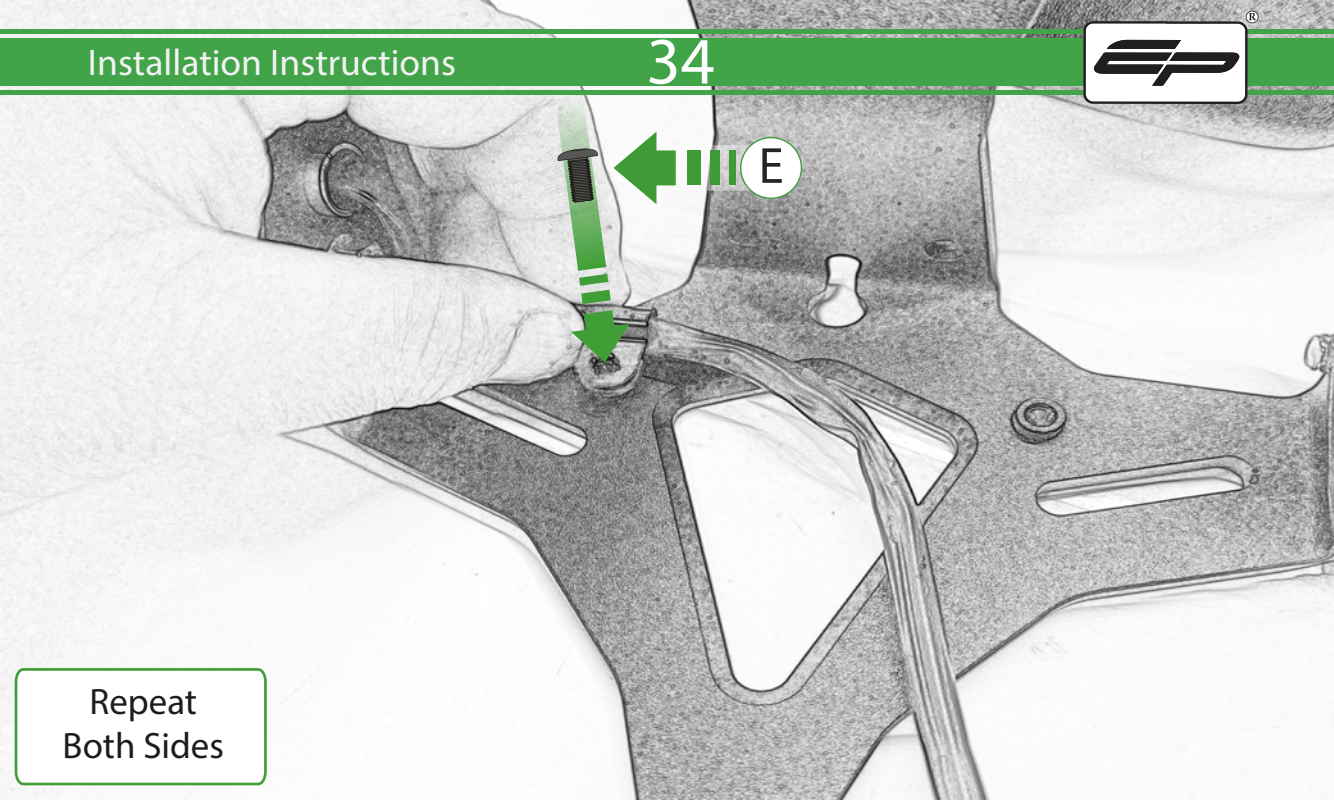

Repeat
Both Sides

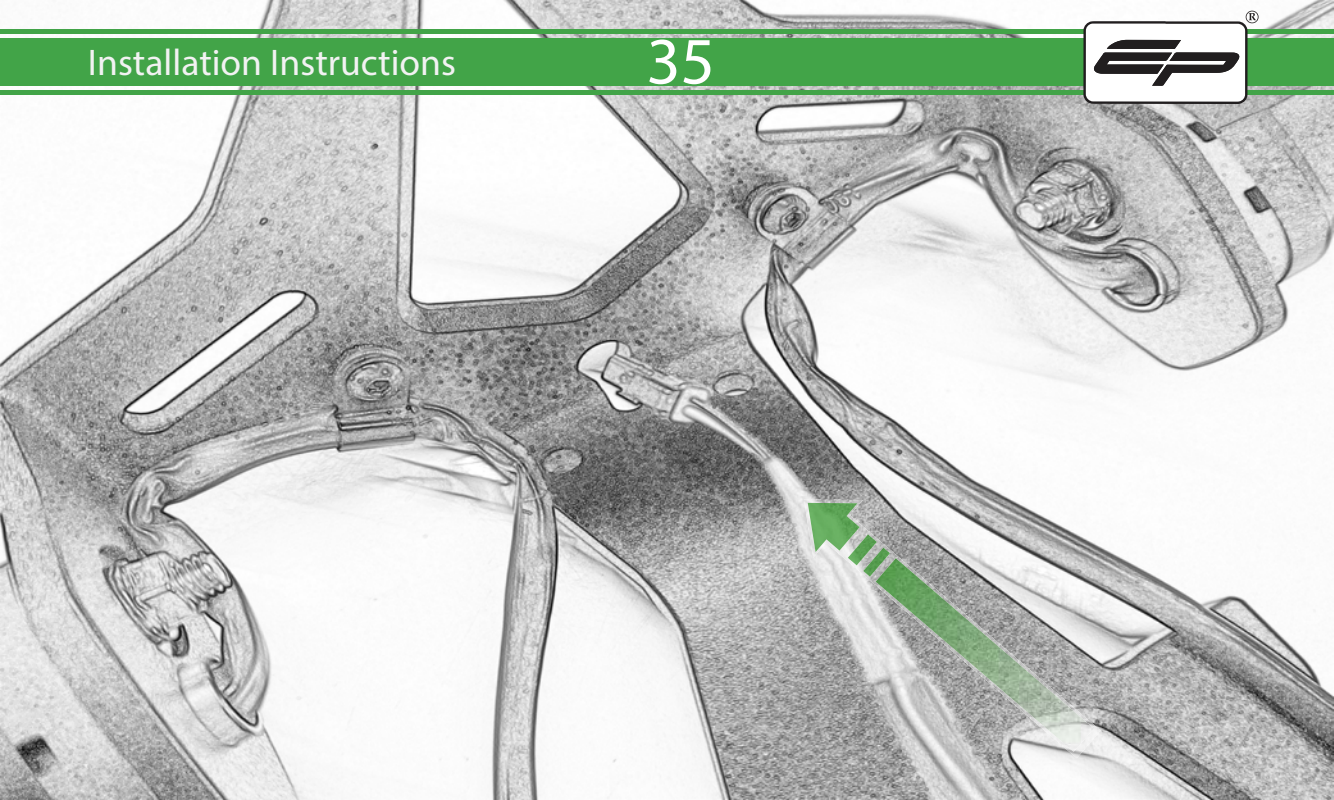

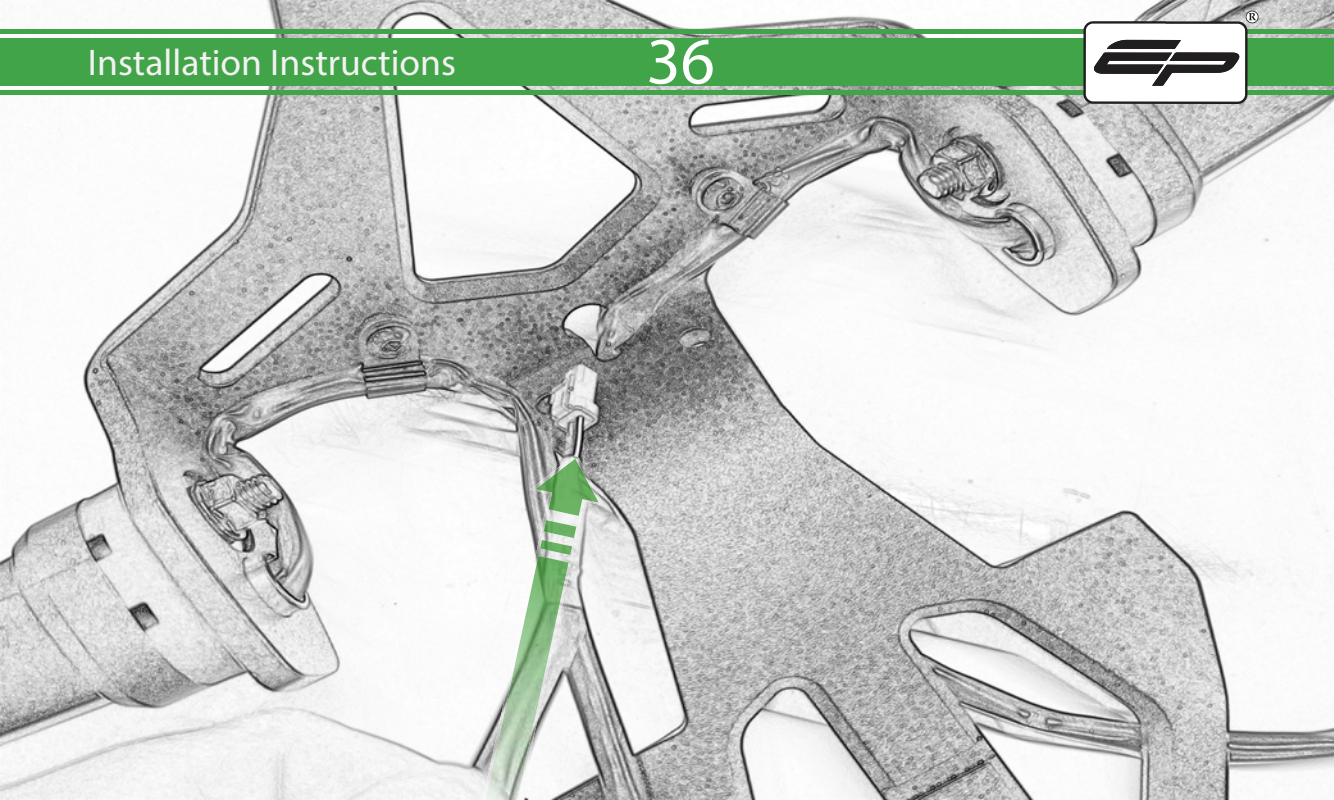

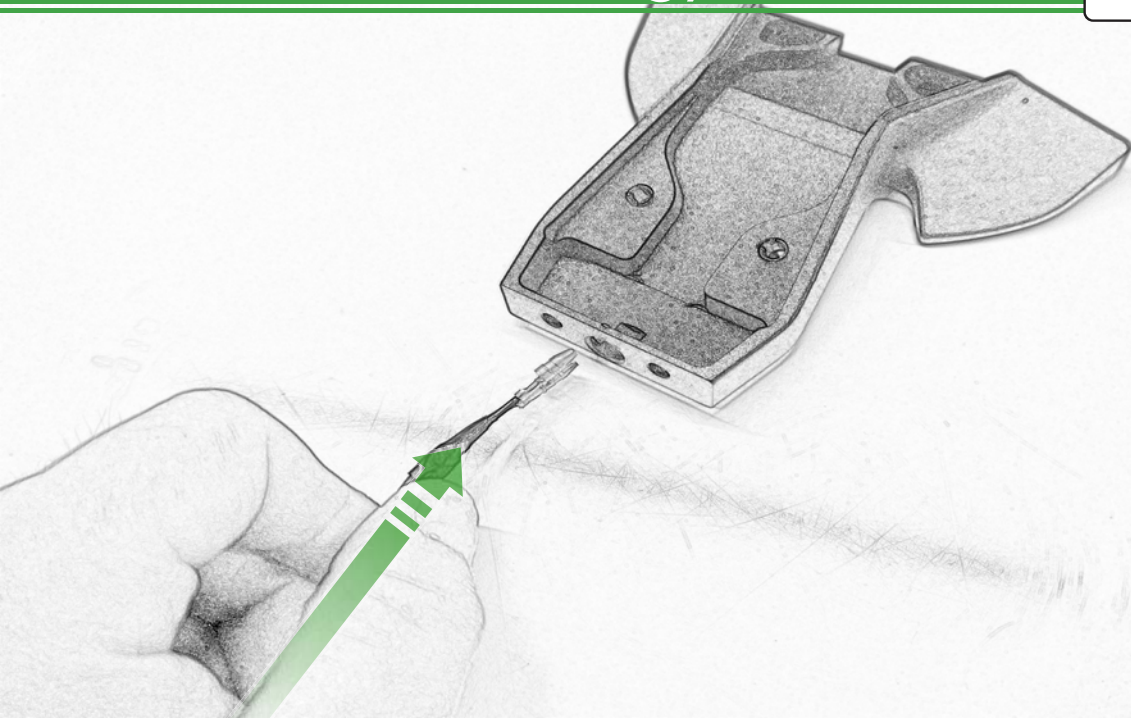

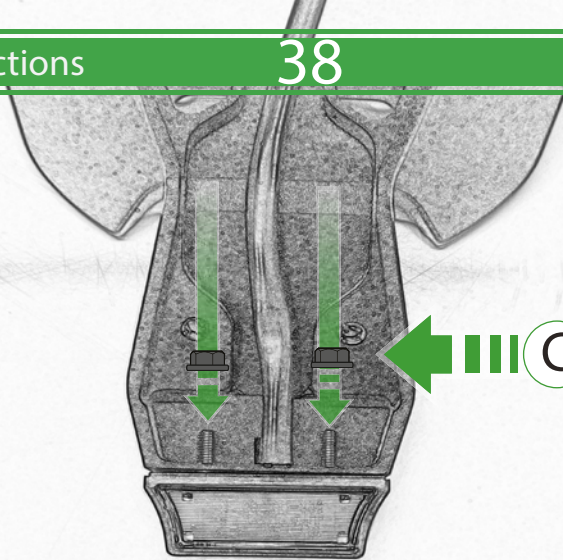

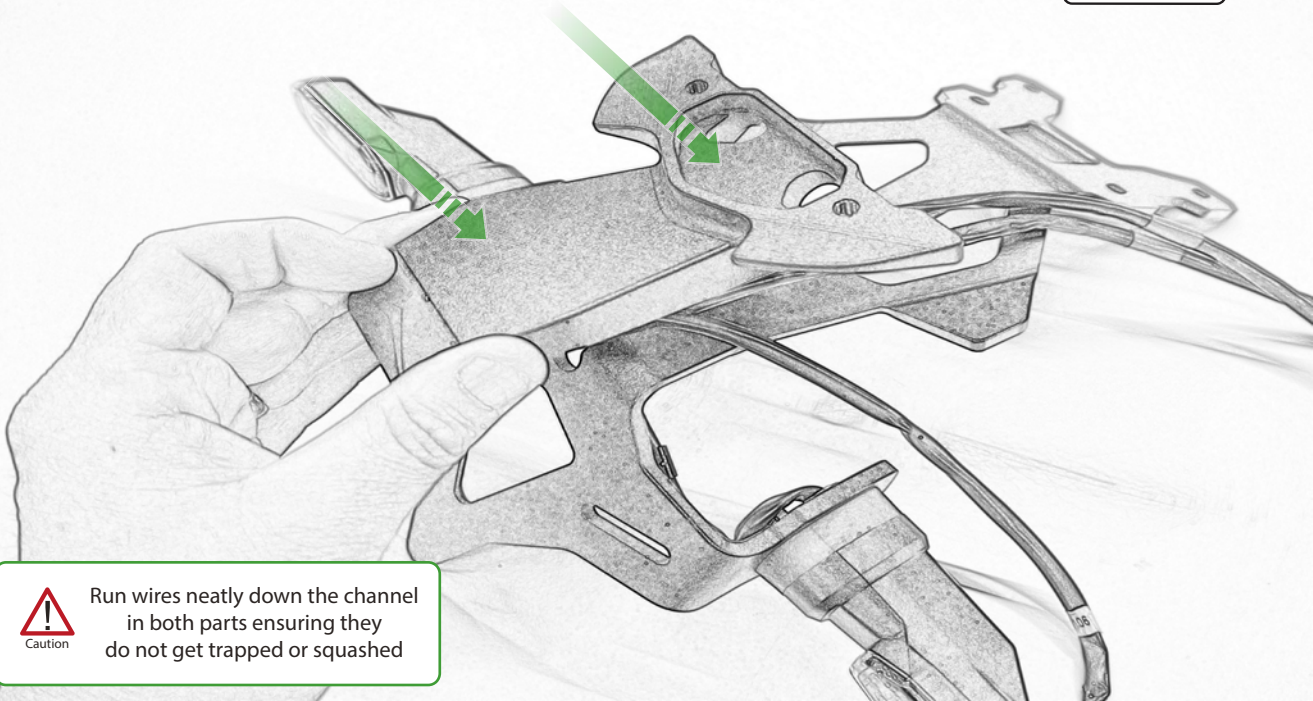

Caution

Run wires neatly down the channel in both parts ensuring they do not get trapped or squashed

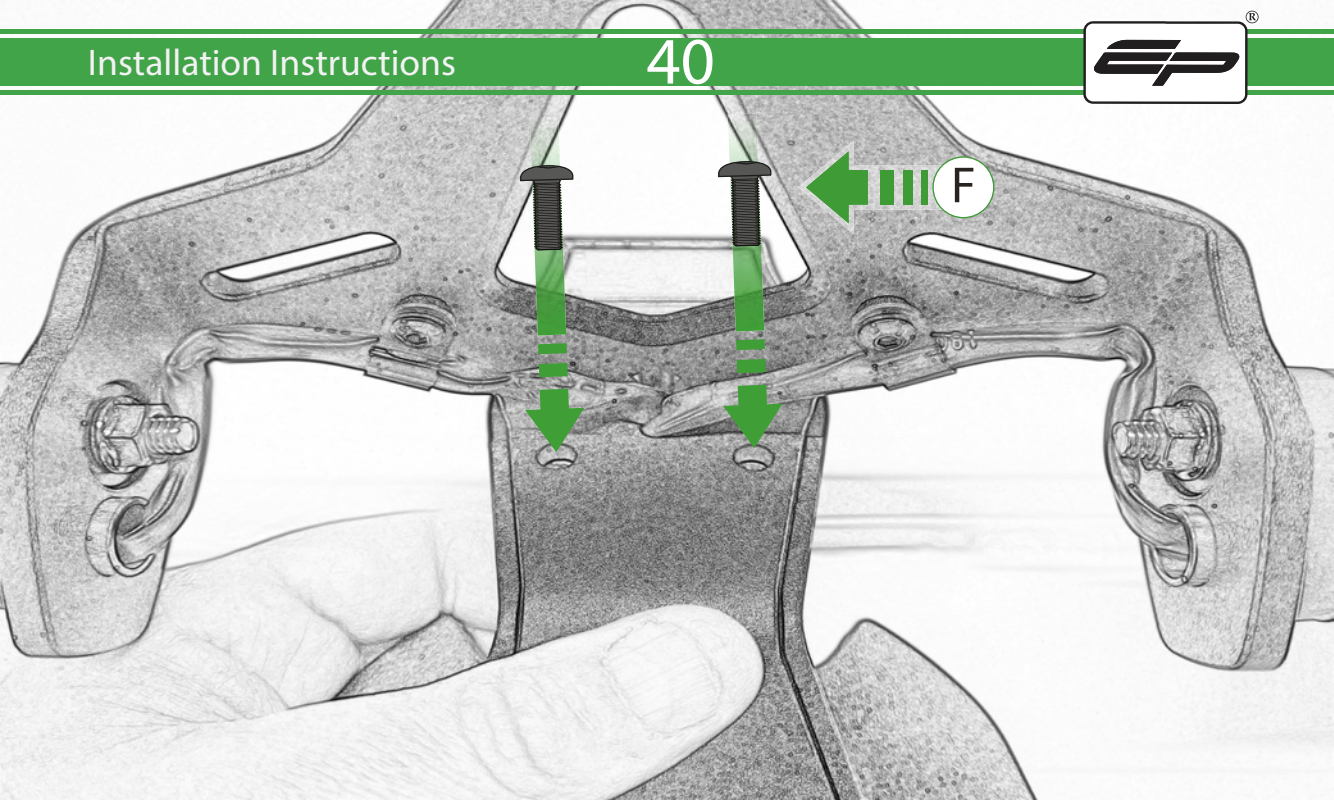

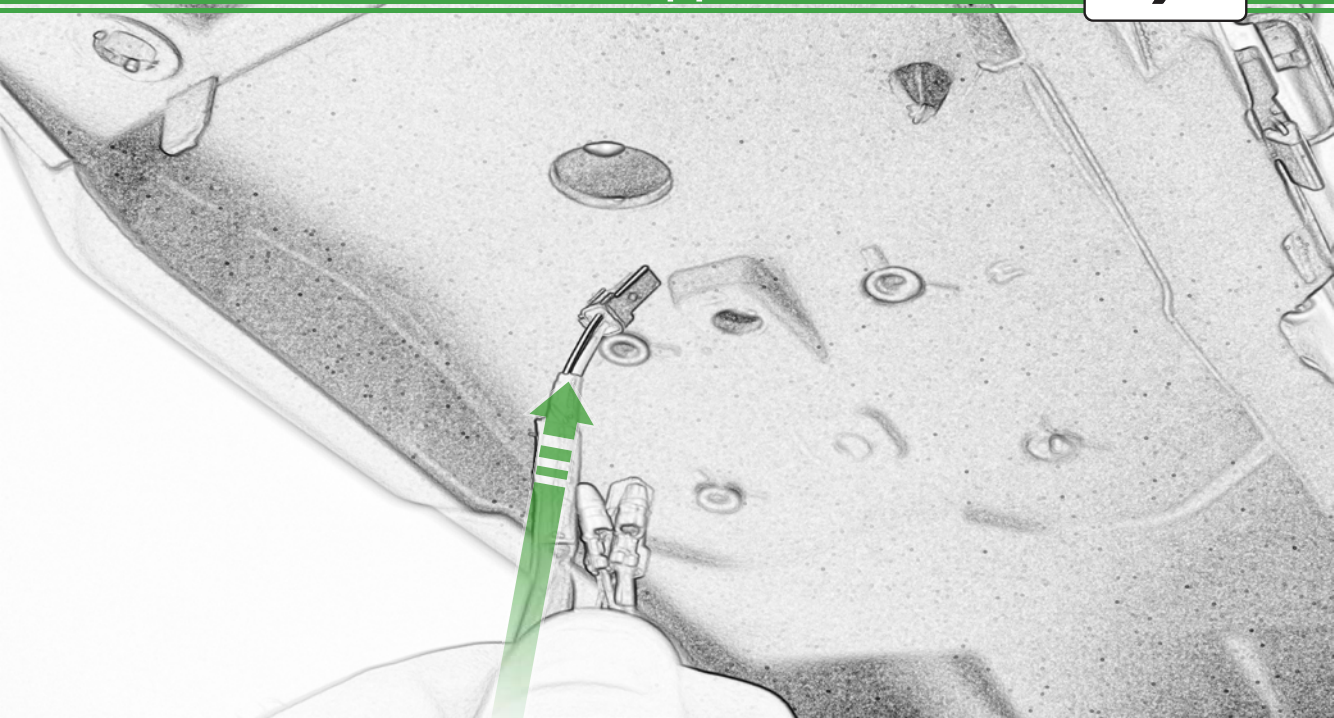



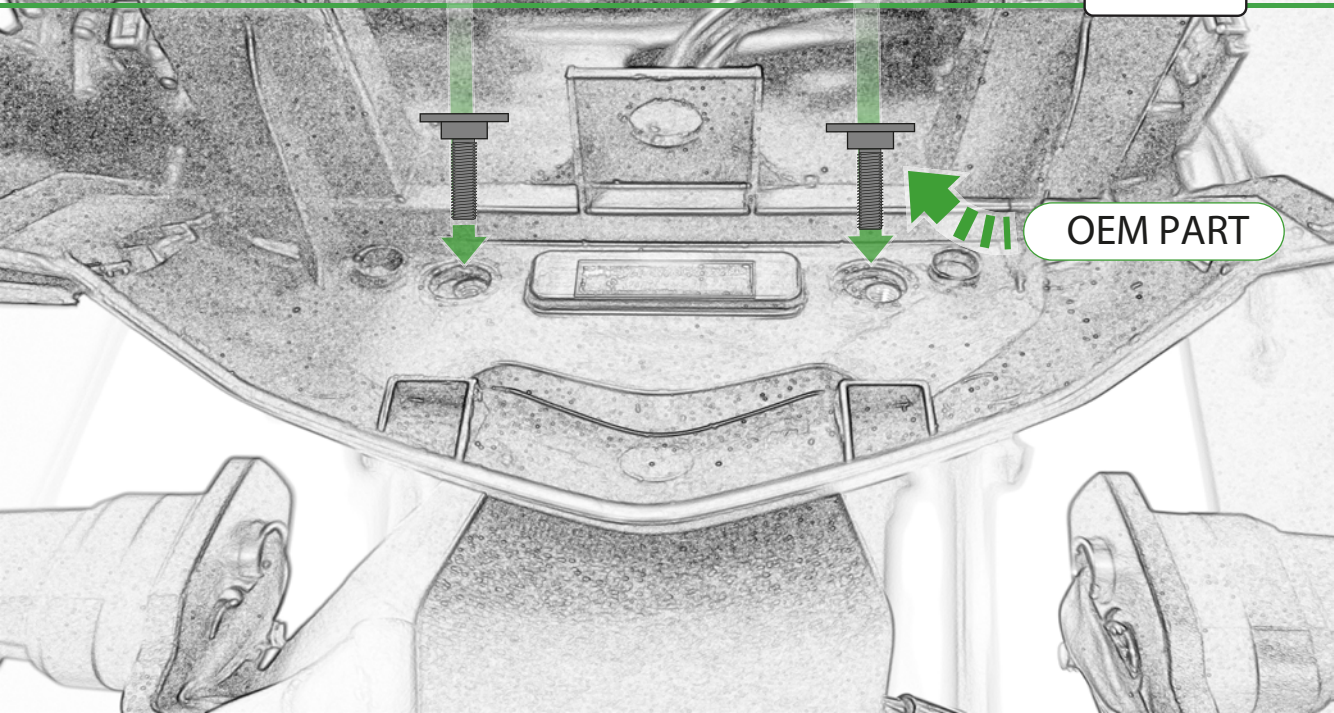

OEM PART

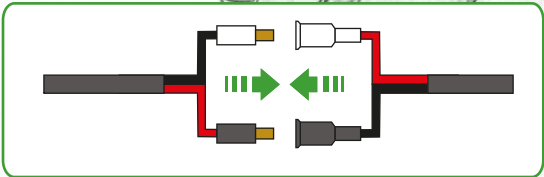
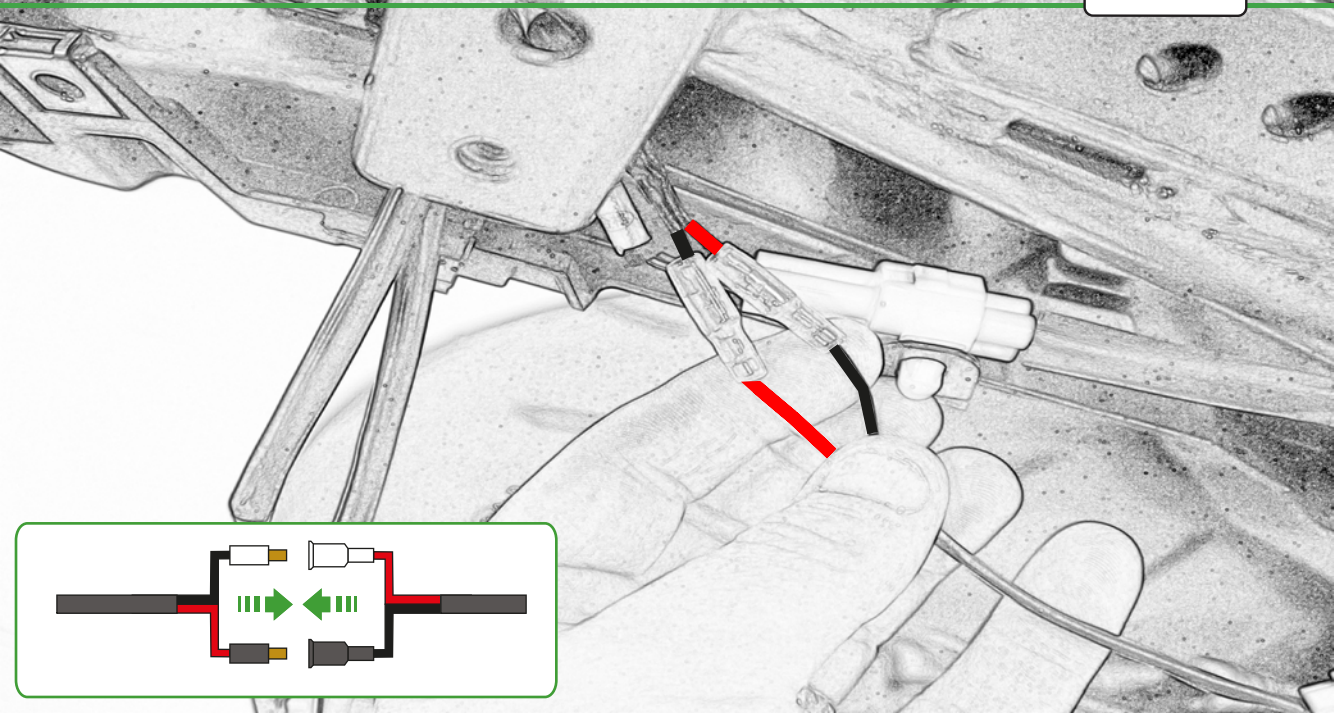



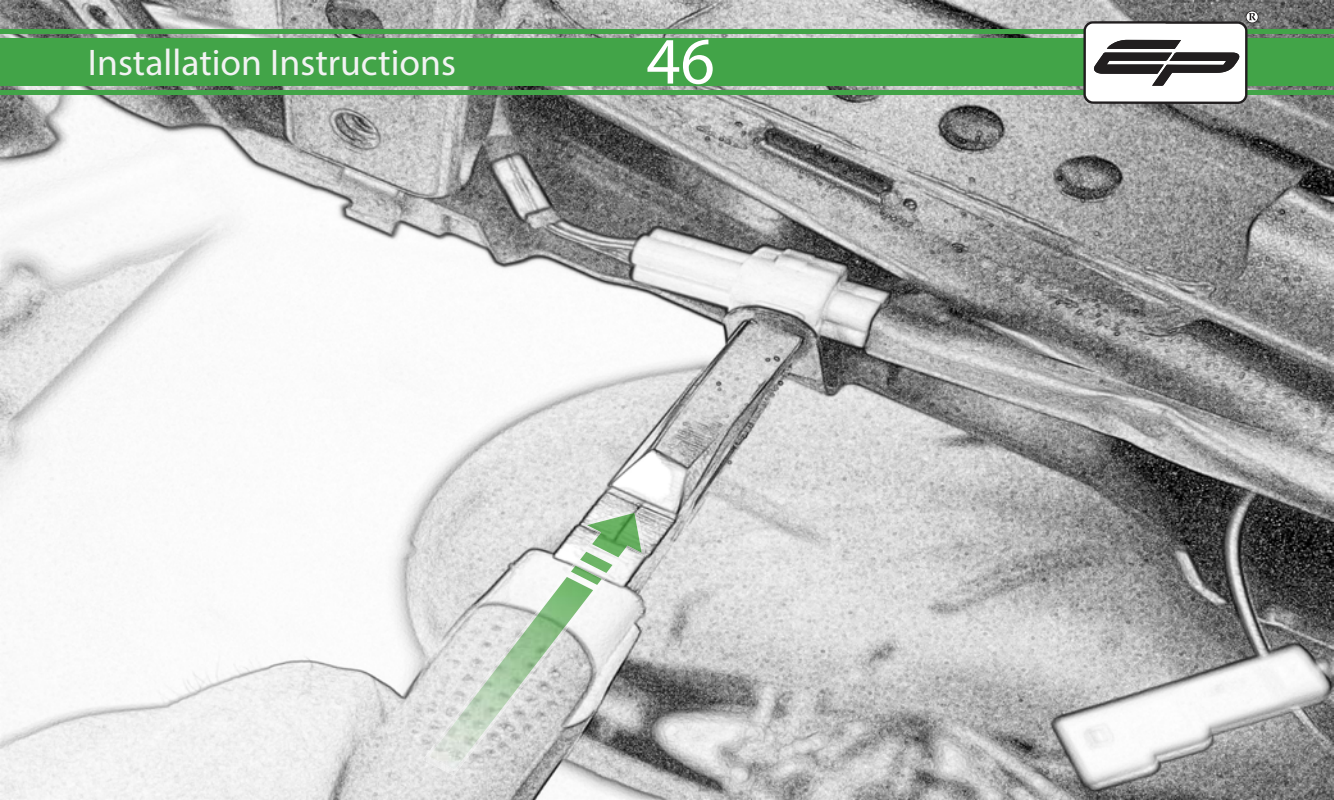

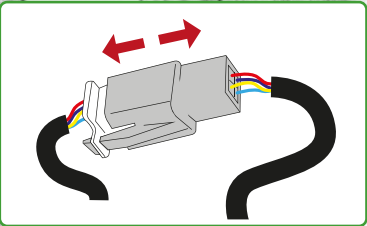
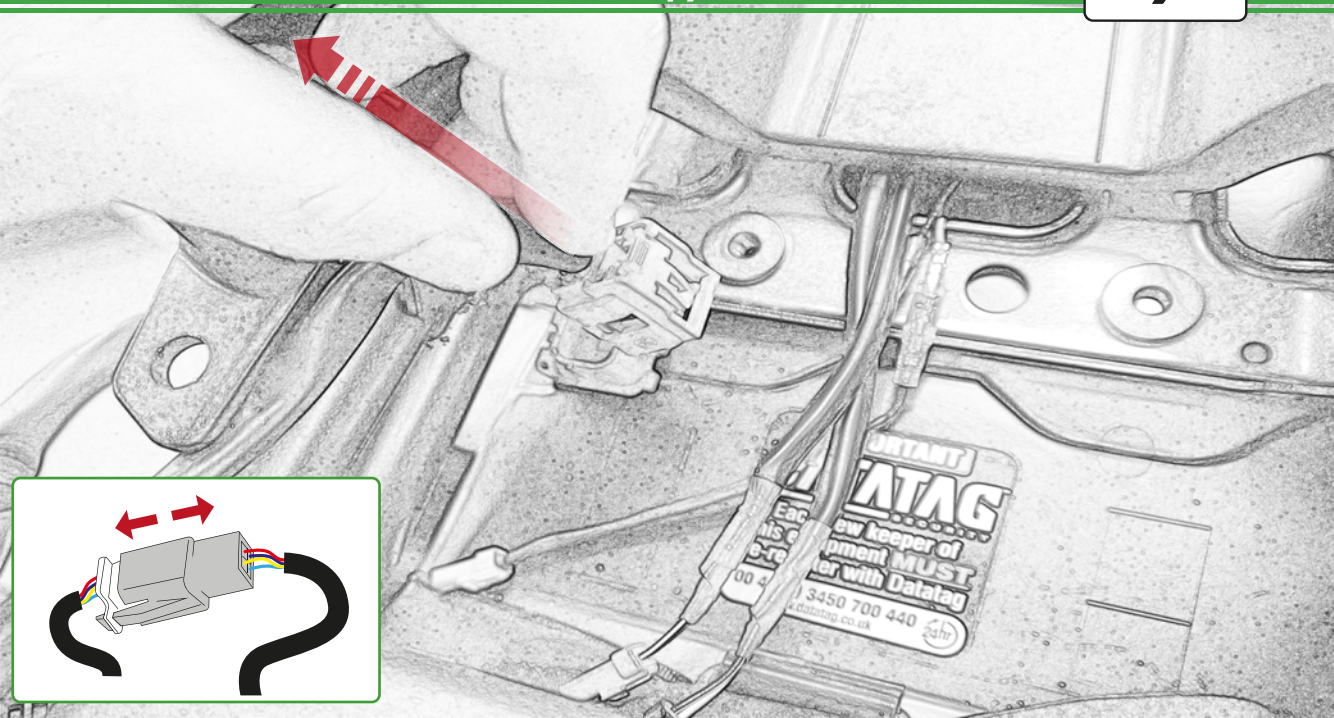

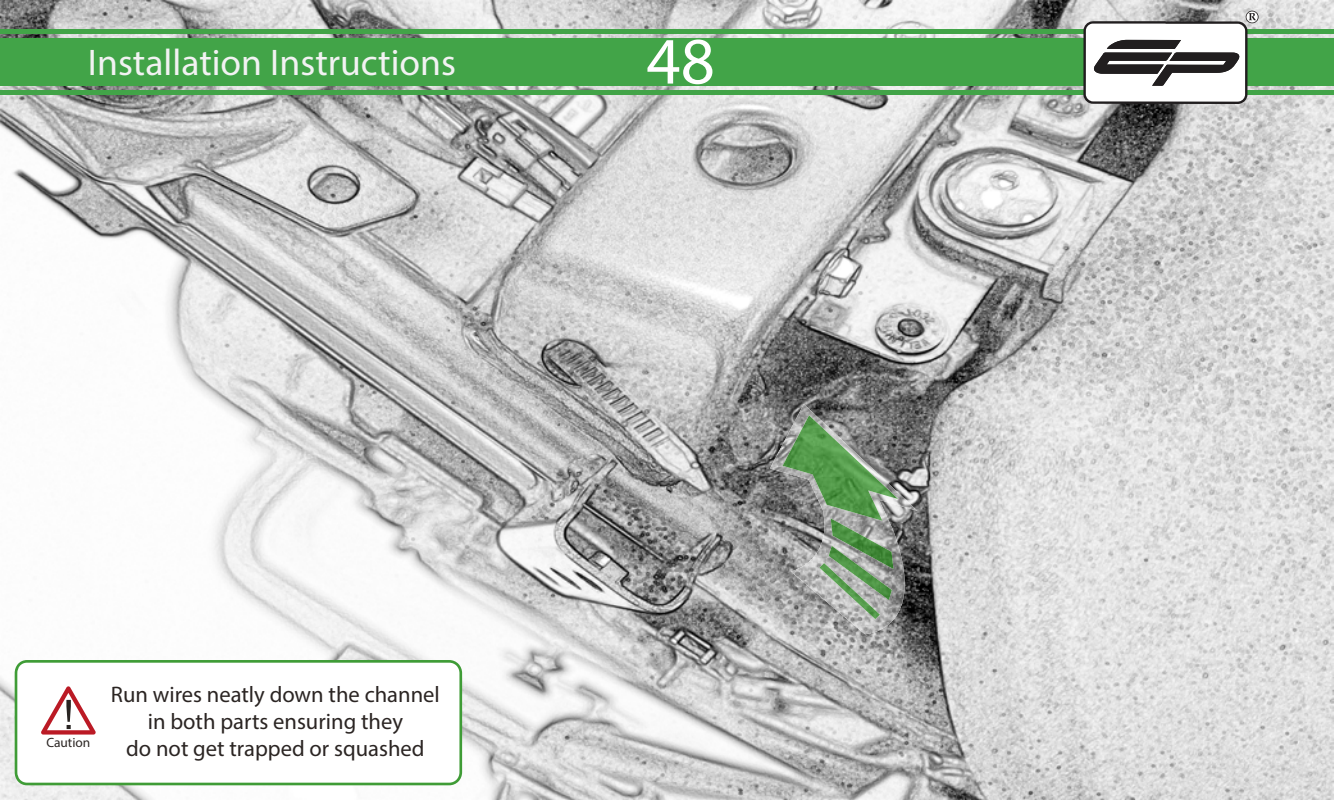

Caution

Run wires neatly down the channel in both parts ensuring they do not get trapped or squashed

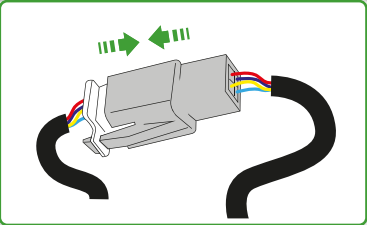
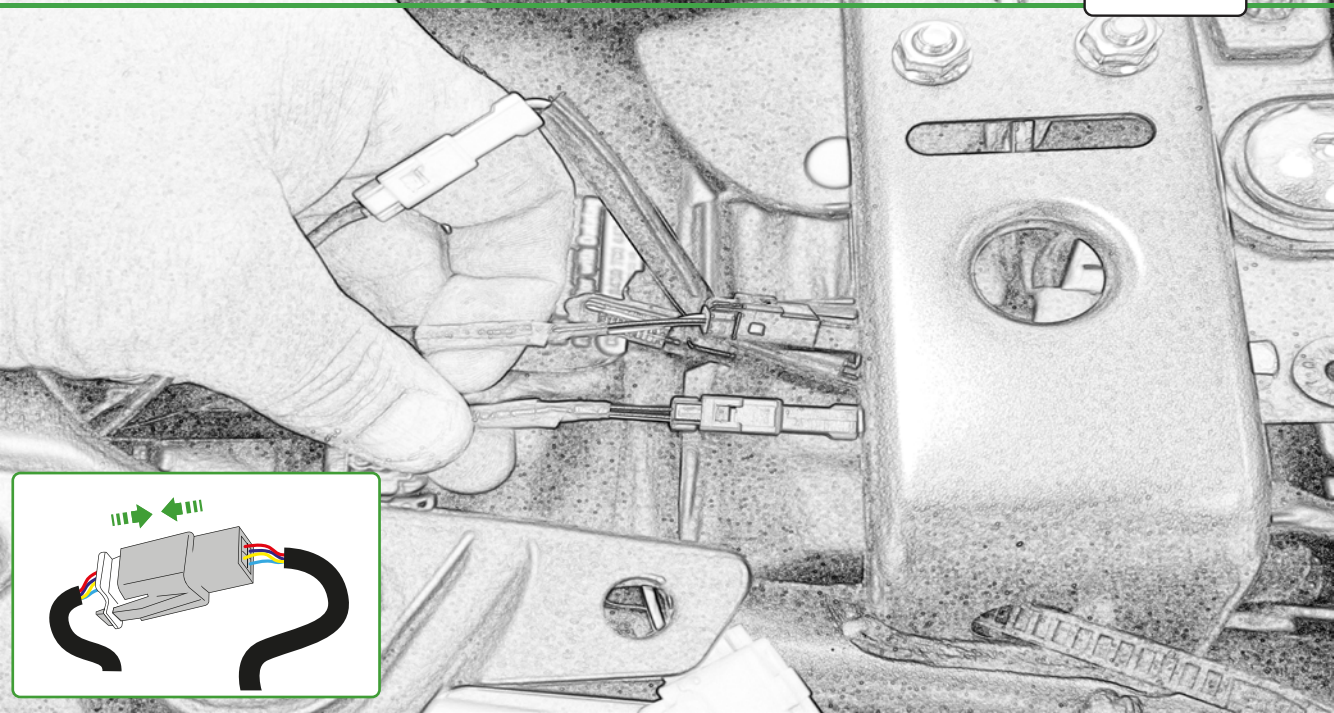

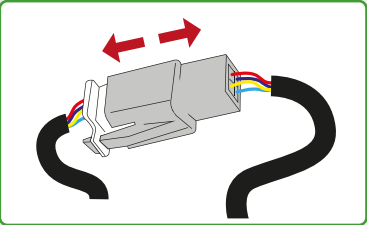
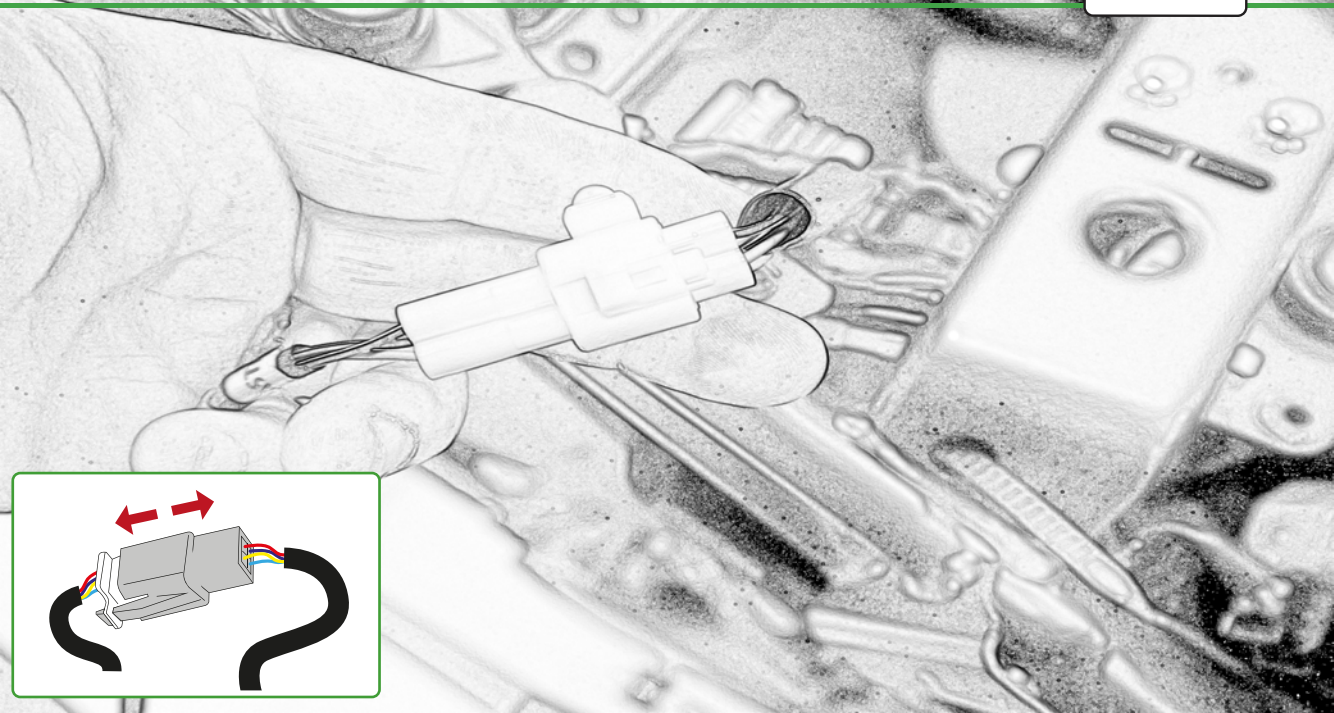

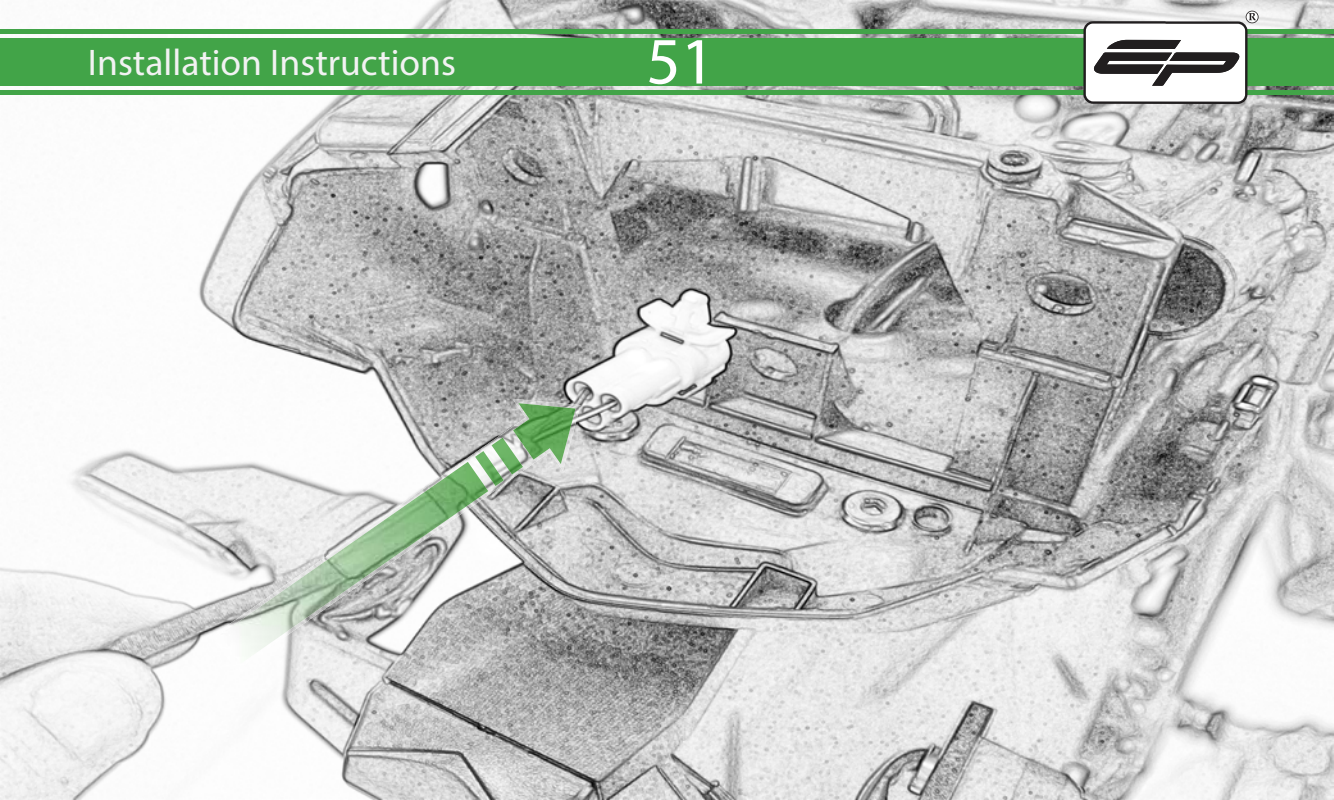



IMPORTANT!
CATATAG
Each new keeper of
this equipment **MUST**
re-register with Catatag
00 44 (0) 3530 700 440 (54)
www.catatag.co.uk

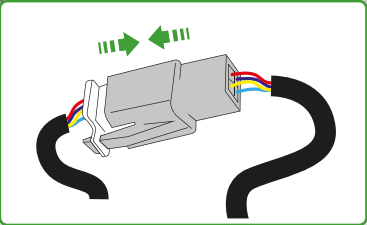
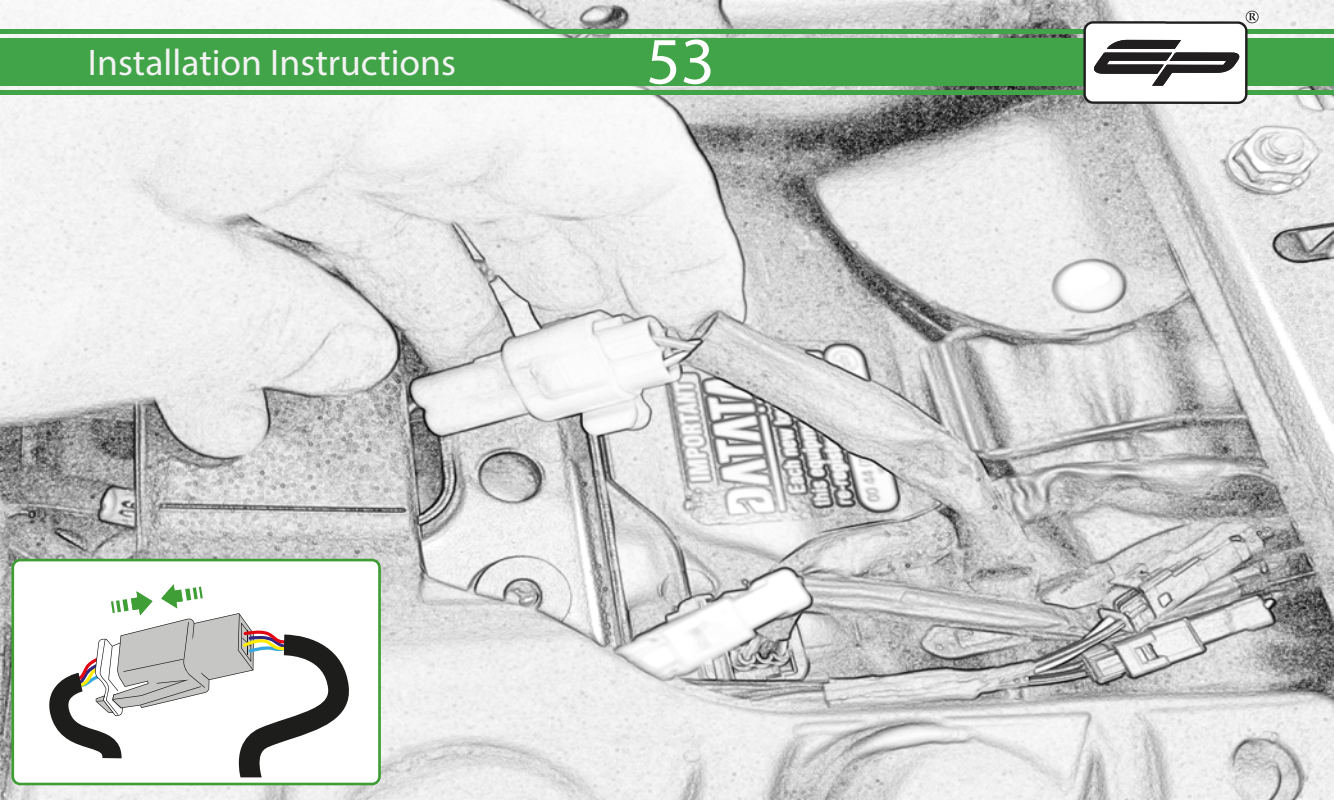

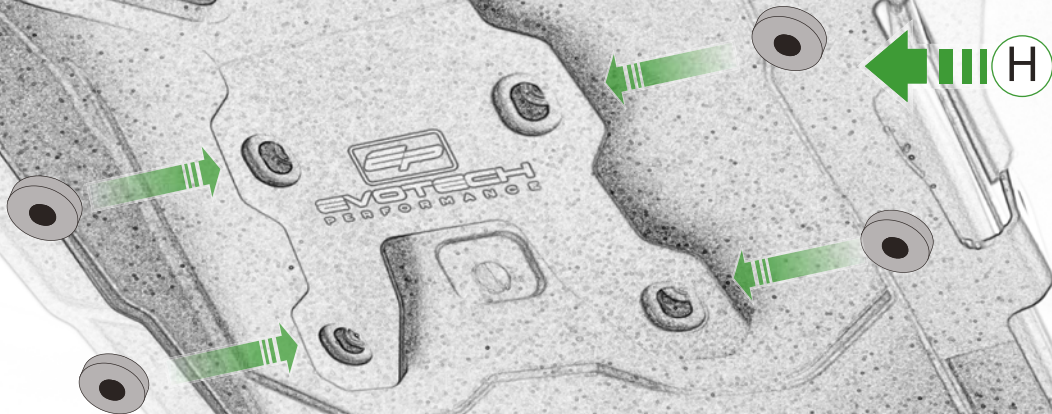

Caution

Install Rubber Washers
Between The Tail Tidy and
The Undertray.

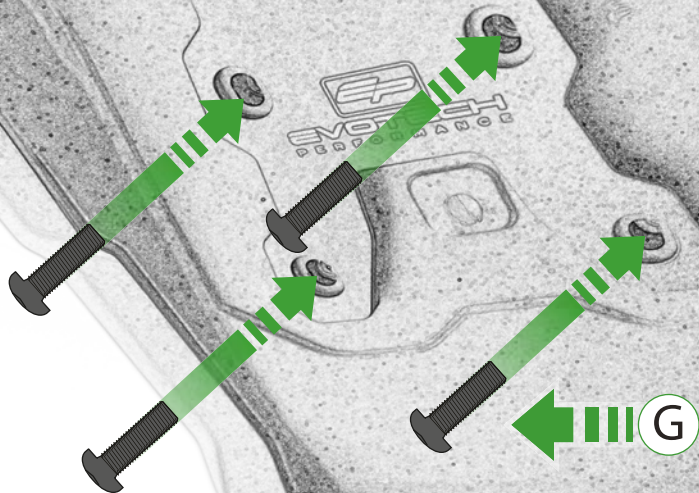



EVOTECH[®]

P E R F O R M A N C E

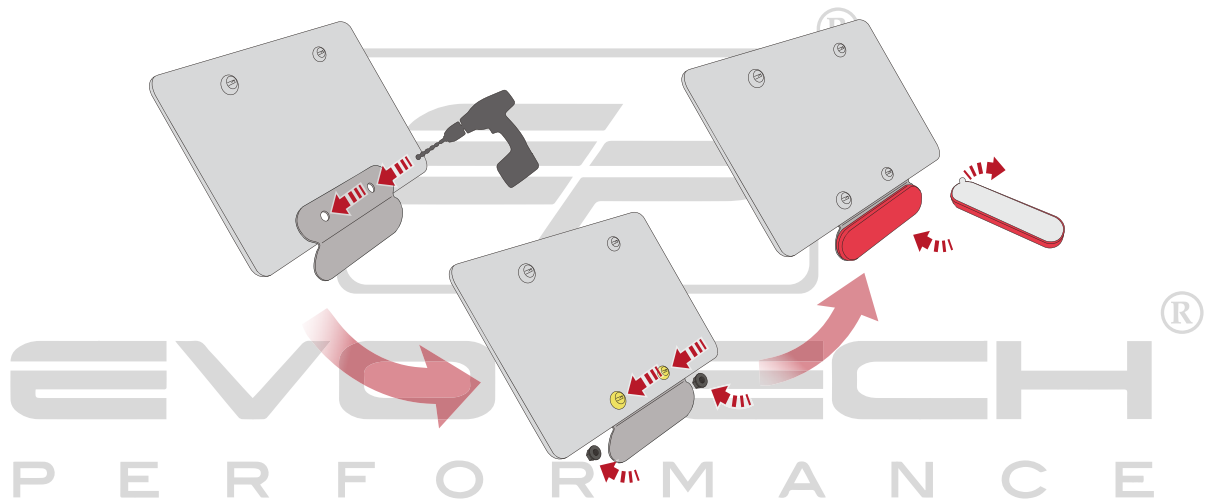

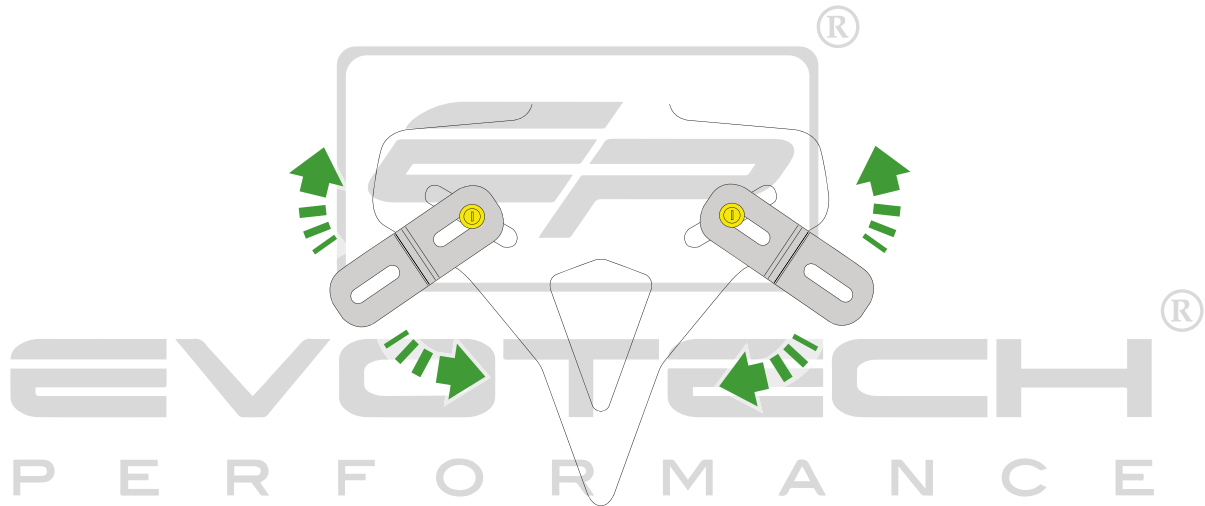



ESSENTIAL CHECKS

After installation of your tail tidy ensure that the licence plate does not contact the rear tyre when suspension is fully compressed.

Ensure all electrics including indicators, tail light, brake light and licence plate light lights are working correctly before riding the motorcycle.

It is recommended that periodic inspections are made to ensure that all fixings are fully tightend.



EVOTECH®
P E R F O R M A N C E

www.evotech-performance.com