

# TN2165 - KN2165

PARAMOTORE SPECIFICO - SPECIFIC ENGINE GUARD - PARE-CARTER SPECIFIQUE - SPEZIFISCHER STURZBÜGEL - DEFENSA DE MOTOR ESPECÍFICA - PARAMOTOR ESPECÍFICO

## YAMAHA TÉNÉRÉ 700 WORLD RAID (2022/2023)

N°	Descrizione/Description	Caratteristiche/Features	Codice/Code	Quantità/Quantity
1	Paramotore - Engine Guard Pare-carter - Sturzbuegel Defensa De Moto - Paramotor	-	2165TNDXV 2165TNSXV	2(Right; Left)
2	Supporto superiore - Support higher - Support supérieur Halteung höher - Soporte superior - Apoio superior	-	GL5423V	1
3	Vite - Screw - Vis - Schraube Tornillo - Parafuso	TBEI M8x18	818TBEI	2
4	Vite - Screw - Vis - Schraube Tornillo - Parafuso	TEF M8x60	860TEF	2
5	Vite - Screw - Vis - Schraube Tornillo - Parafuso	TBEI M6x20	620TBEI	2
6	Vite - Screw - Vis - Schraube Tornillo - Parafuso	TBEI M8x50	850TBEI	4
7	Vite - Screw - Vis - Schraube Tornillo - Parafuso	TECF M6x30	630TECF	2
8	Rondella - Washer - Rondelle - Scheibe Arandela - Arruela	Foro Ø8mm	8RON	2
9	Rondella spaccata - Split washer Scheibe - Rondelle fendue Arandela seccionada - Arruela Dentada	Foro Ø8mm	Z1060	6
10	Rondella - Washer - Rondelle - Scheibe Arandela - Arruela	Foro Ø8mm / Esterno Ø14mm Sp.0,3mm	805RONX	2
11	Rondella - Washer - Rondelle - Scheibe Arandela - Arruela	Foro Ø8mm / Esterno Ø14mm Sp.2mm	814RON	6
12	Rondella Svasata - Flared Washer Rondelle Evasee - Unterlegscheibe Arandela Alargada - Arruela Cônica	Foro Ø6mm / Esterno Ø18mm Sp.1,5mm	618RONP	2
13	Rondella - Washer - Rondelle - Scheibe Arandela - Arruela	Foro Ø6mm / Esterno Ø18mm	618RON	2
14	Rondella Inox - Stainless Steel Washer Rondelle Inox - Rostfreie Unterlegscheibe Aus Stahl Arandela Inox - Arruela Lisa De Aço Inox	Foro Ø6mm / Esterno Ø16mm Sp.2mm	616RONX	2
15	Distanziale - Spacer Entretoise - Distanzstueck Distanciador - Espaçador	Ø24x18 Foro 10,5mm	C18L18F8,5T	4
16	Dado - Bolt - Erou Mutter - Tuerca - Porca	Dado Autobloccante Flangiato M8 (H9,5mm)	8DADIFN	2
17	O-RING	-	Z2161	4
18	Tappo - Cap Fiche - Stecker Enchufe - Capa	-	25TAPBA	2
19	Nipples	-	347TNM	1
20	Nipples	-	V906T	1

# TN2165 - KN2165

PARAMOTORE SPECIFICO - SPECIFIC ENGINE GUARD - PARE-CARTER SPECIFIQUE - SPEZIFISCHER STURZBÜGEL - DEFENSA DE MOTOR ESPECÍFICA - PARAMOTOR ESPECÍFICO

## YAMAHA TÉNÉRÉ 700 WORLD RAID (2022/2023)

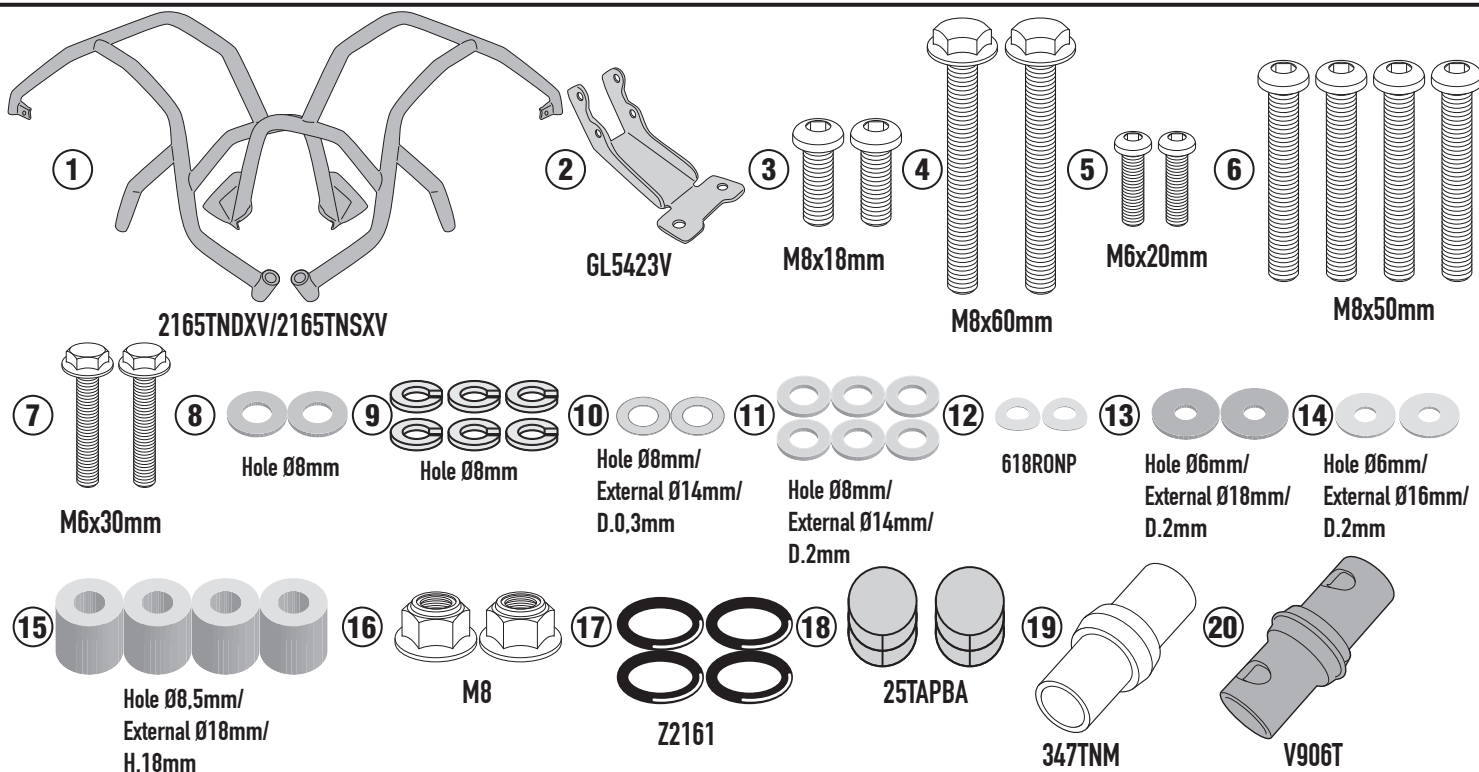

2165TNDXV/2165TNSXV

GL5423V

M8x18mm

M8x60mm

M6x20mm

M8x50mm

M6x30mm

Hole Ø8mm

Hole Ø8mm

Hole Ø8mm/  
External Ø14mm/  
D.0.3mm

Hole Ø8mm/  
External Ø14mm/  
D.2mm

618RONP

Hole Ø6mm/  
External Ø18mm/  
D.2mm

Hole Ø6mm/  
External Ø16mm/  
D.2mm

Hole Ø8.5mm/  
External Ø18mm/  
H.18mm

M8

Z2161

25TAPBA

347TNM

V906T

IT\_ Paramotore progettato in modo tale da non essere il primo elemento a toccare terra con il veicolo in configurazione originale. Rilevamenti effettuati con veicolo aggiornato al 21/04/2023

EN\_ Engine guard designed so that it is not the first element to touch the ground with the vehicle in its original configuration. Analysis conducted with updated vehicle at 21/04/2023.

DE\_ Sturzbügel, der so konstruiert ist, dass er nicht als erstes Element den Boden berührt, wenn das Fahrzeug in Originalkonfiguration ist. Messungen mit zum ---.2023 aktualisiertem Fahrzeug durchgeführt

FR\_ Pare-carter conçu de manière à ne pas être le premier élément à toucher le sol avec le véhicule dans sa configuration d'origine. Enquêtes réalisées avec véhicule mis à jour au 21/04/2023

ES\_ Defensa de motor diseñado de tal manera que no sea el primer elemento en tocar tierra con el vehículo en la configuración original. Mediciones efectuadas con el vehículo actualizado al 21/04/2023

PT\_ Protetor de motor elaborado para não ser o primeiro elemento a tocar o piso com o veículo na configuração original. Vistorias realizadas com veículo atualizado em 21/04/2023

IT\_ Si raccomanda di fare eseguire il montaggio ad un meccanico qualificato.

Nel caso in cui sulle viti originali sia presente del frenafiletto, ripristinarlo durante il montaggio dell'accessorio.

EN\_ We recommend fitting by a qualified mechanic.

If there is threadlocker on the original screws, use threadlocker when mounting the accessory.

DE\_ Wir empfehlen, dass die Montage von einem Fachmechaniker durchgeführt wird.

Falls sich auf den Originalschrauben Schraubensicherungsklebstoff befand, sollte dieser auch bei der Montage des Zubehörs wieder aufgetragen werden.

FR\_ Il est recommandé de faire le montage par un mécanicien qualifié.

Si du frein filet est présent sur les vis d'origine, l'appliquer également lors du montage de l'accessoire.

ES\_ Se recomienda realizar el montaje por un mecánico cualificado.

En caso de que el fijador de roscas se encuentre presente en los tornillos originales, colocarlo nuevamente en el montaje del accesorio.

PT\_ Recomendamos a fixação por um mecânico qualificado

Se houver trava rosca nos parafusos originais, inserir novamente durante a montagem do acessório.

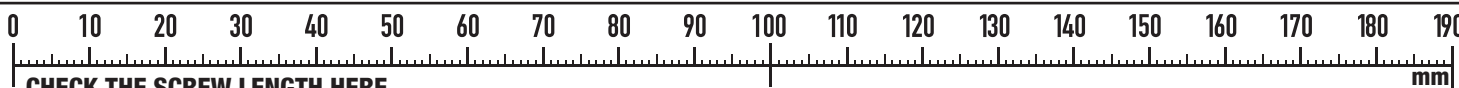
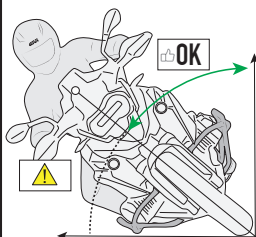

ISTRUZIONI DI MONTAGGIO - MOUNTING INSTRUCTIONS  
INSTRUCTIONS DE MONTAGE - BAUANLEITUNG  
INSTRUCCIONES DE MONTAJE - INSTRUÇÕES DE MONTAGEM

# TN2165 - KN2165

PARAMOTORE SPECIFICO - SPECIFIC ENGINE GUARD - PARE-CARTER SPECIFIQUE - SPEZIFISCHER STURZBÜGEL - DEFENSA DE MOTOR ESPECÍFICA - PARAMOTOR ESPECÍFICO

## YAMAHA TÉNÉRÉ 700 WORLD RAID (2022/2023)

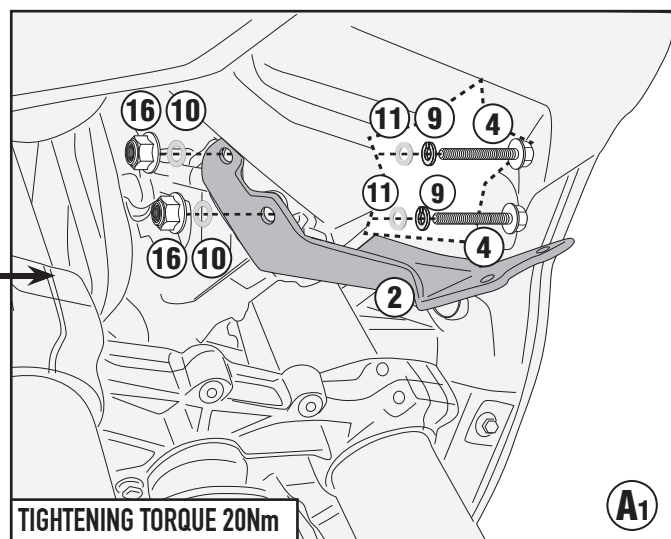
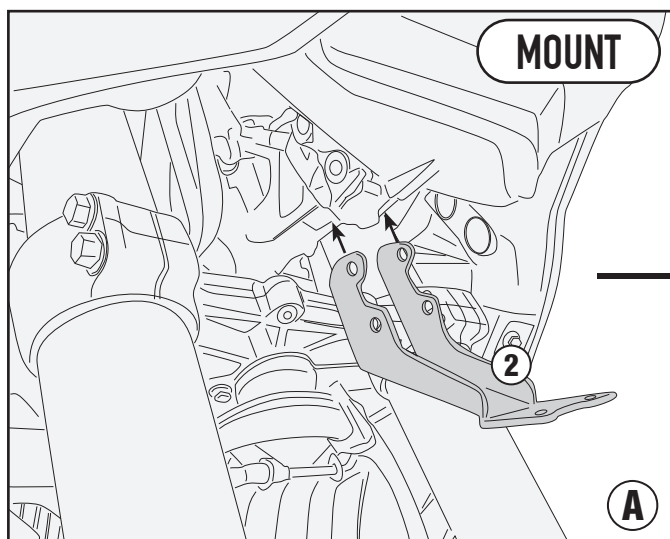
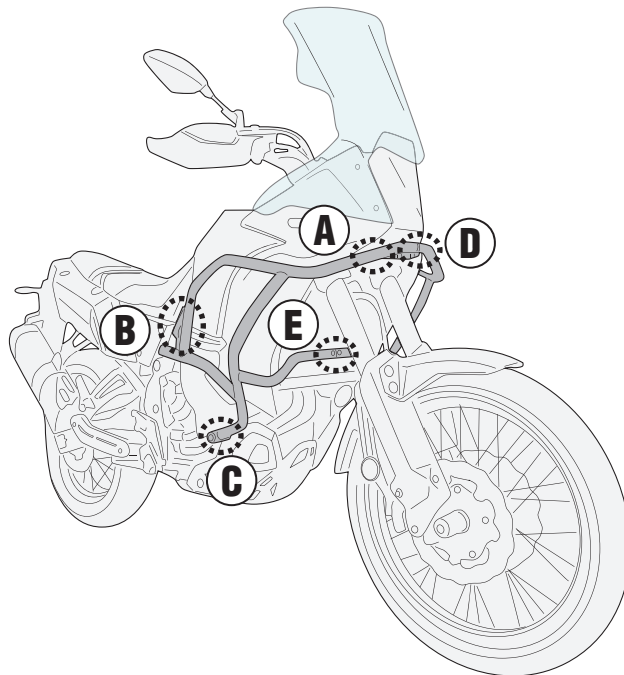

### RIGHT SIDE/ LEFT SIDE

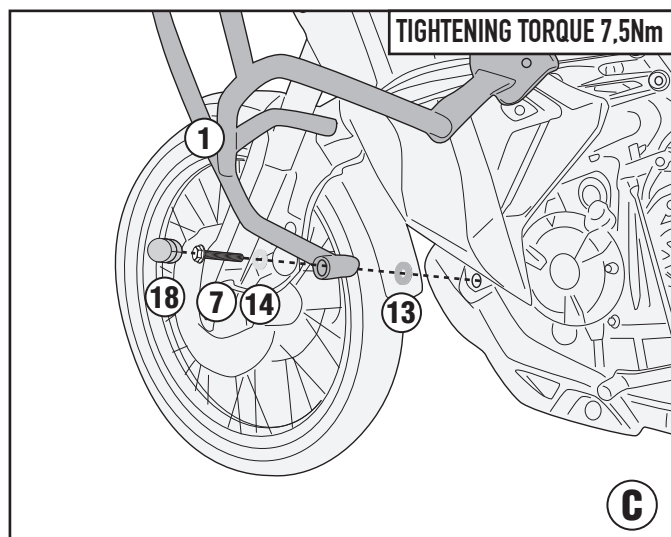
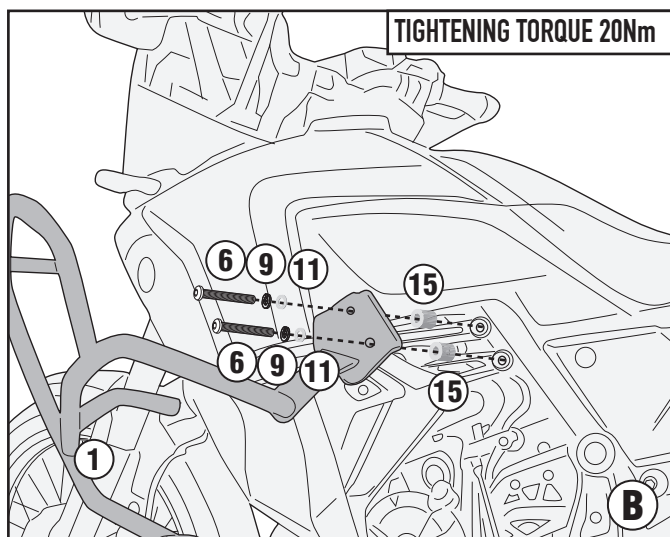

ISTRUZIONI DI MONTAGGIO - MOUNTING INSTRUCTIONS  
INSTRUCTIONS DE MONTAGE - BAUANLEITUNG  
INSTRUCCIONES DE MONTAJE - INSTRUÇÕES DE MONTAGEM

# TN2165 - KN2165

PARAMOTORE SPECIFICO - SPECIFIC ENGINE GUARD - PARE-CARTER SPECIFIQUE - SPEZIFISCHER STURZBÜGEL - DEFENSA DE MOTOR ESPECÍFICA - PARAMOTOR ESPECÍFICO

## YAMAHA TÉNÉRÉ 700 WORLD RAID (2022/2023)

