



EVOTECH[®]
P E R F O R M A N C E

www.evotech-performance.com

EP Kawasaki Ninja / Z 1000SX Tail Tidy

Installation Instructions



Kit Contents PRN011740

- (A) 1 x LED Bracket
- (B) 2 x Main Plate
- (C) 2 x Sub Plate
- (D) 2 x M4 x 12 Button Head Bolts
- (E) 2 x Light Spacer
- (F) 2 x M4 x 16 Button Head Bolts
- (G) 4 x Base Spacers
- (H) 4 x M6 x 35 Button Head Bolts
- (I) 4 x M6 Flange nuts

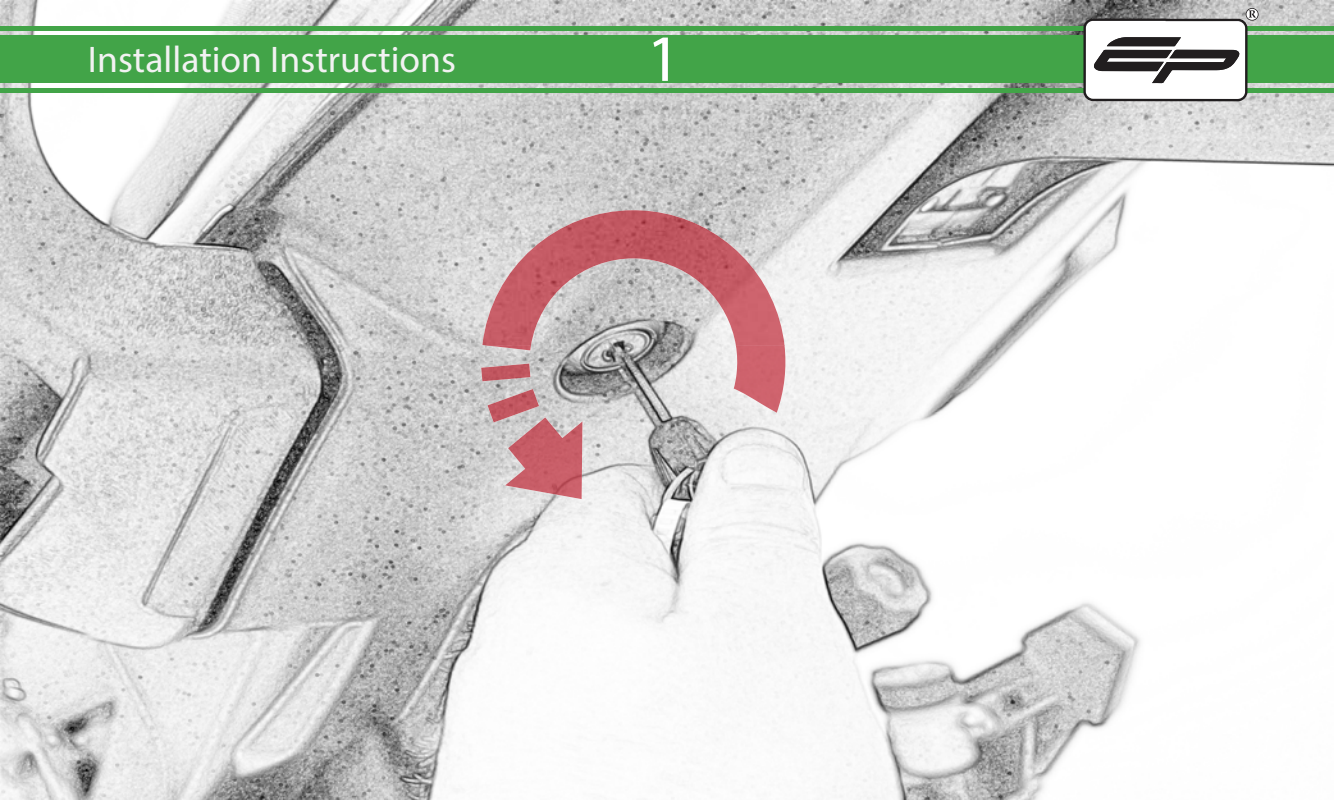

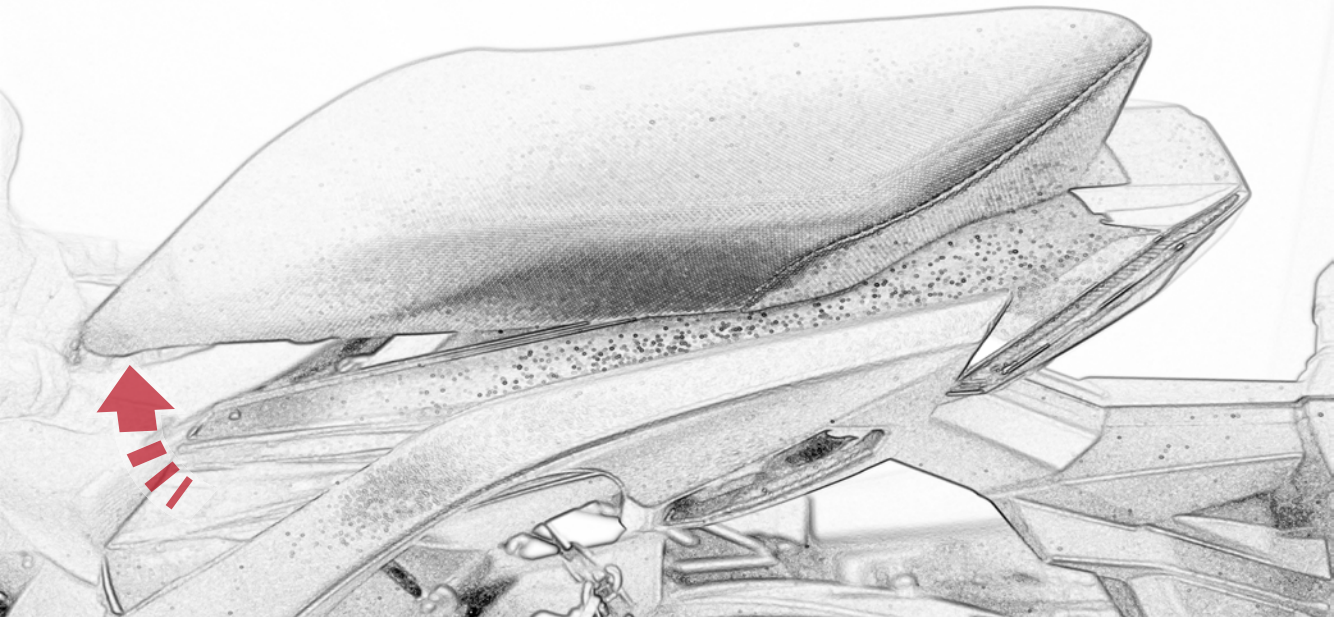

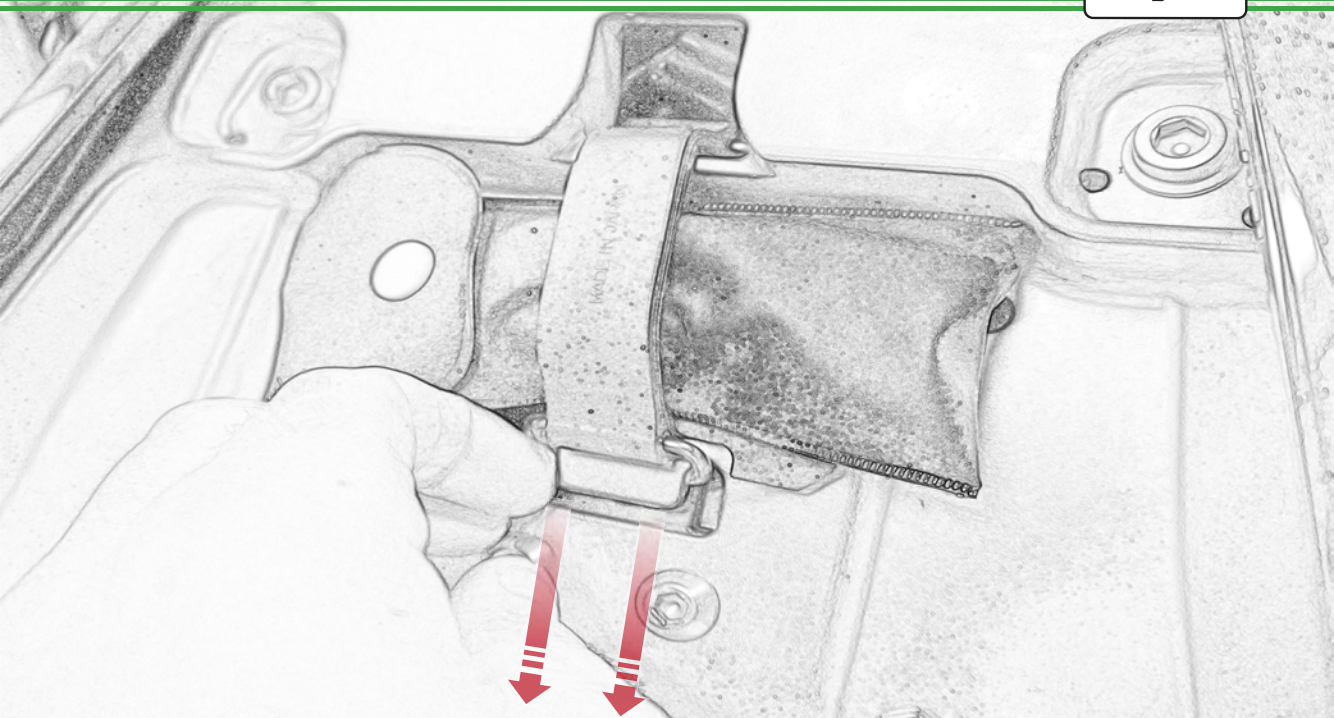

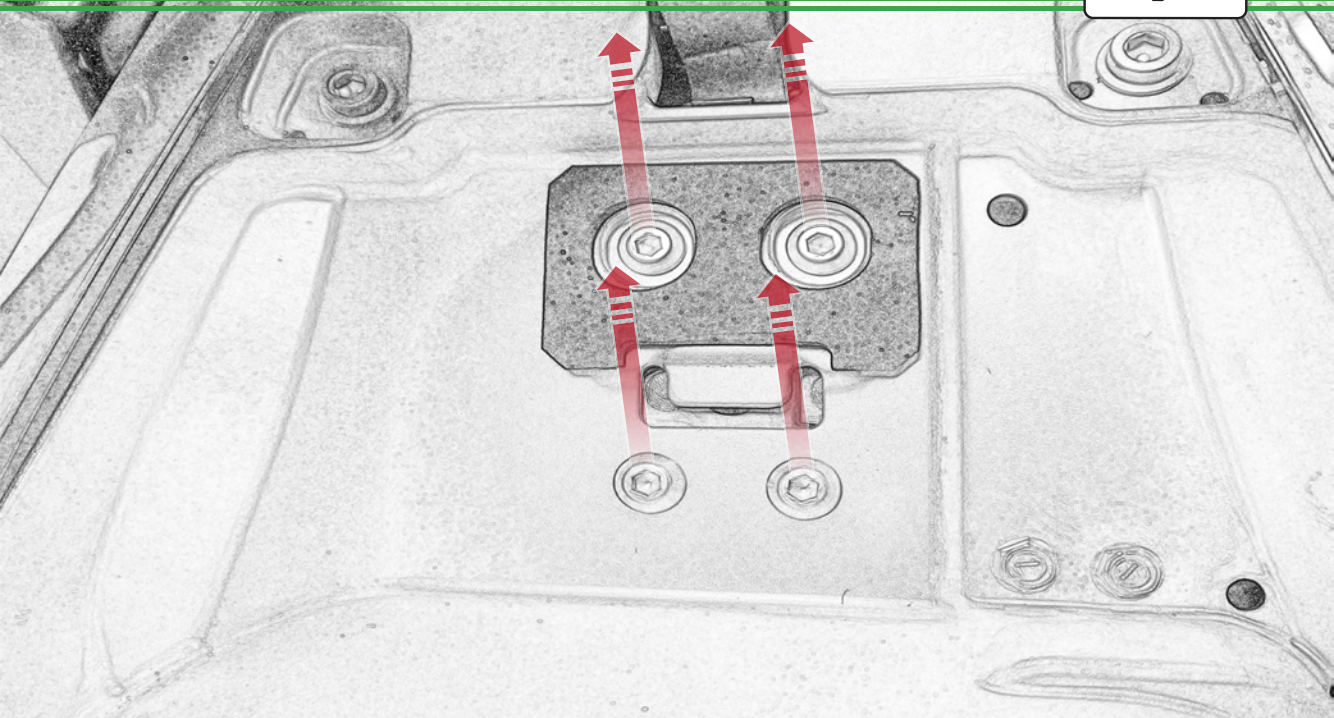

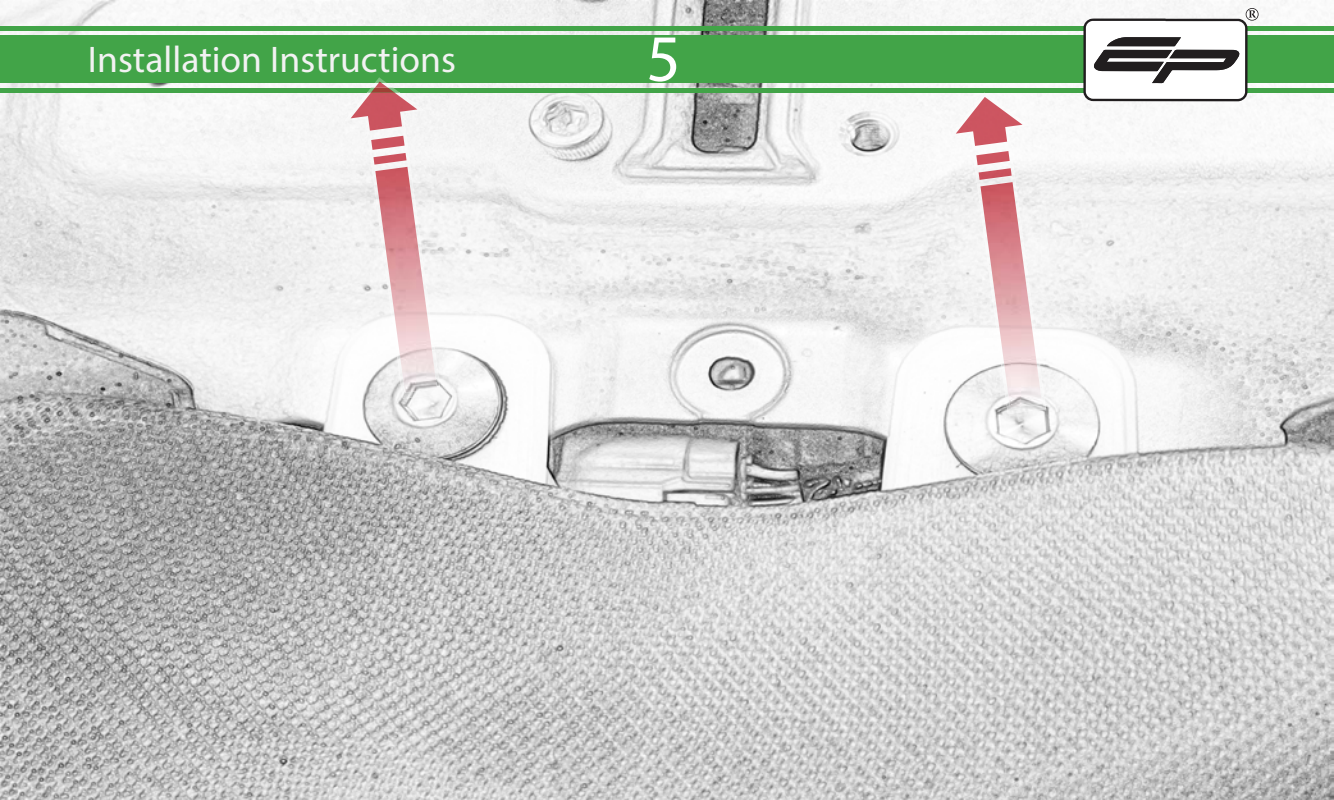

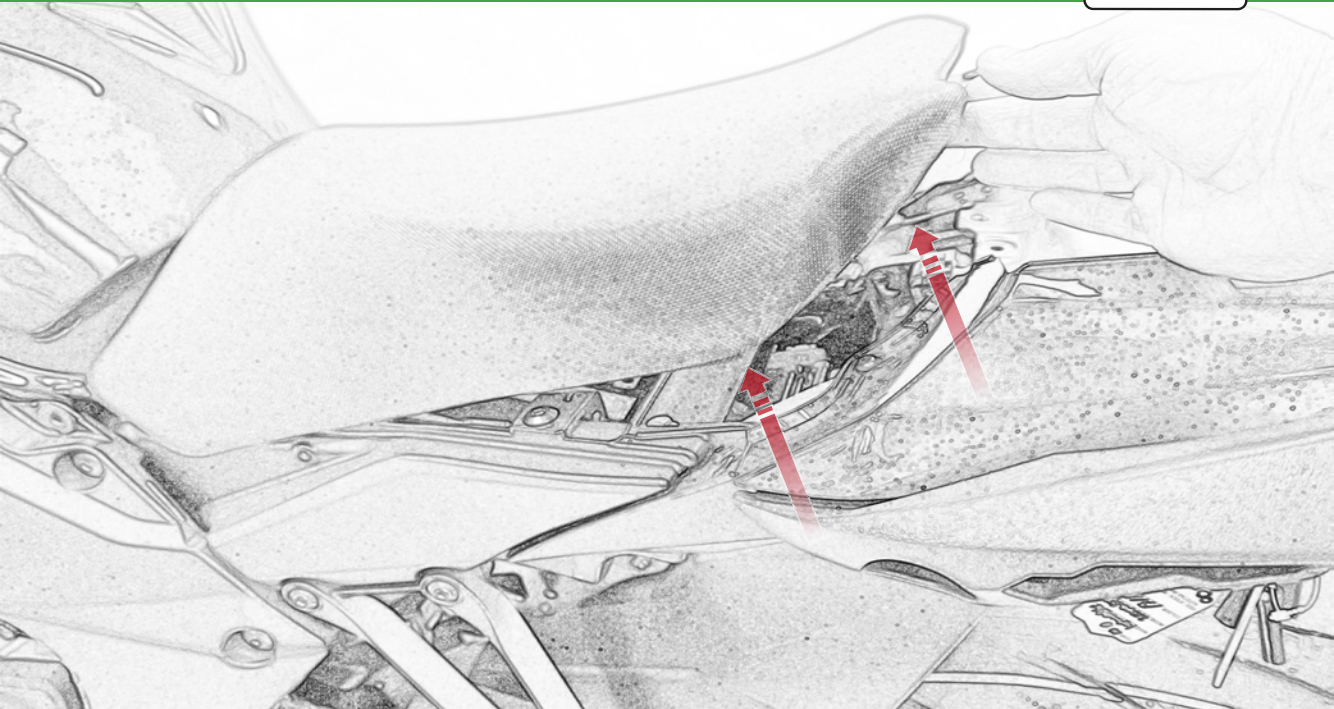

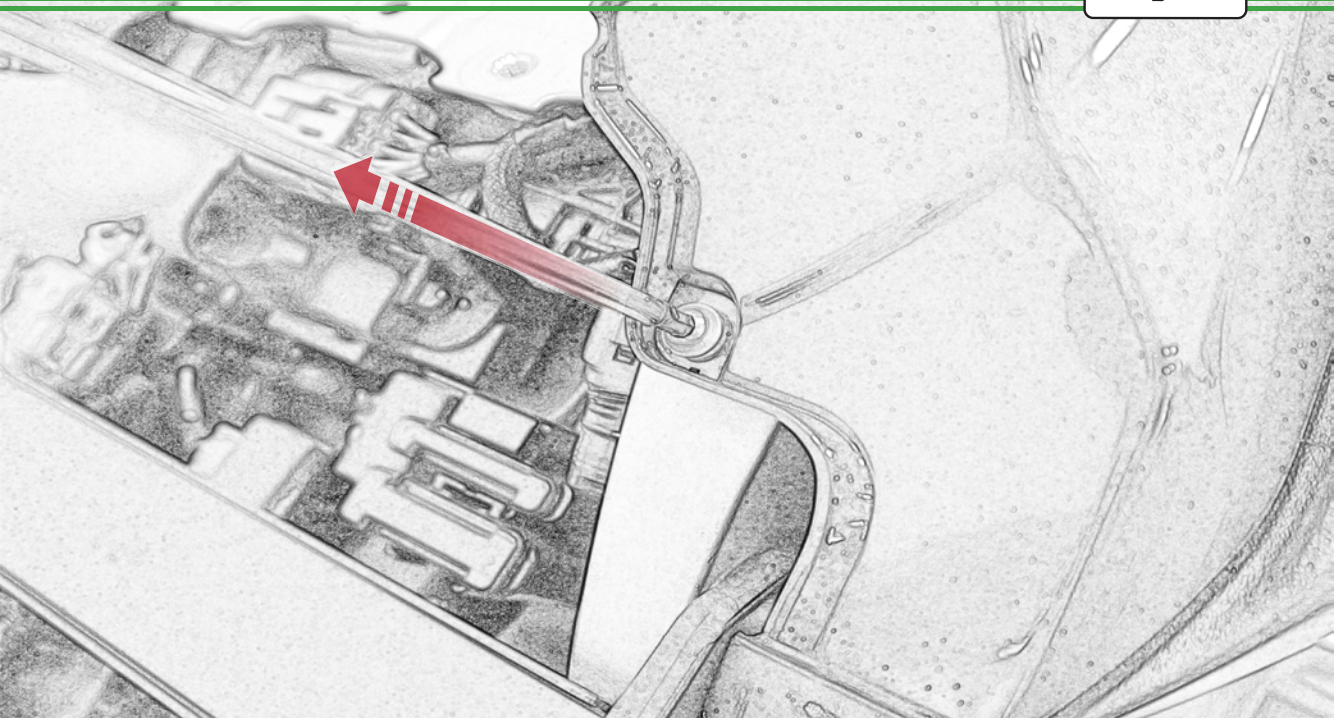

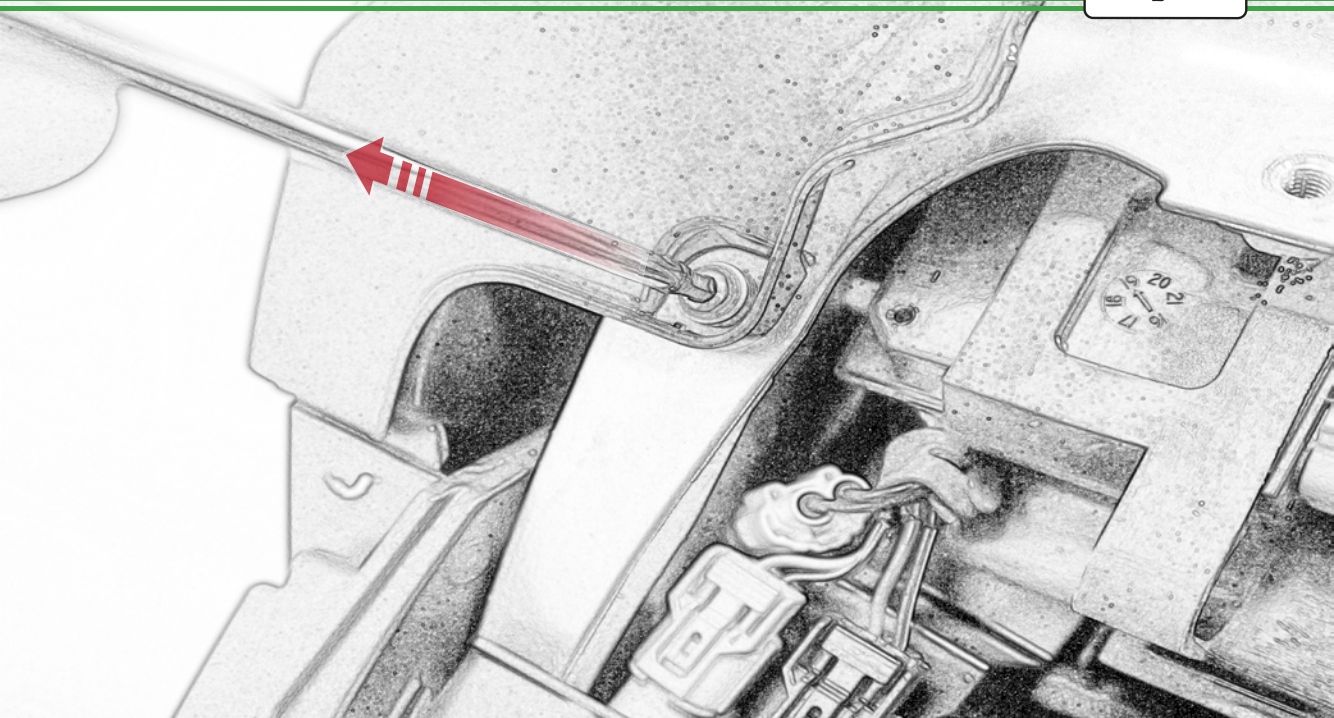





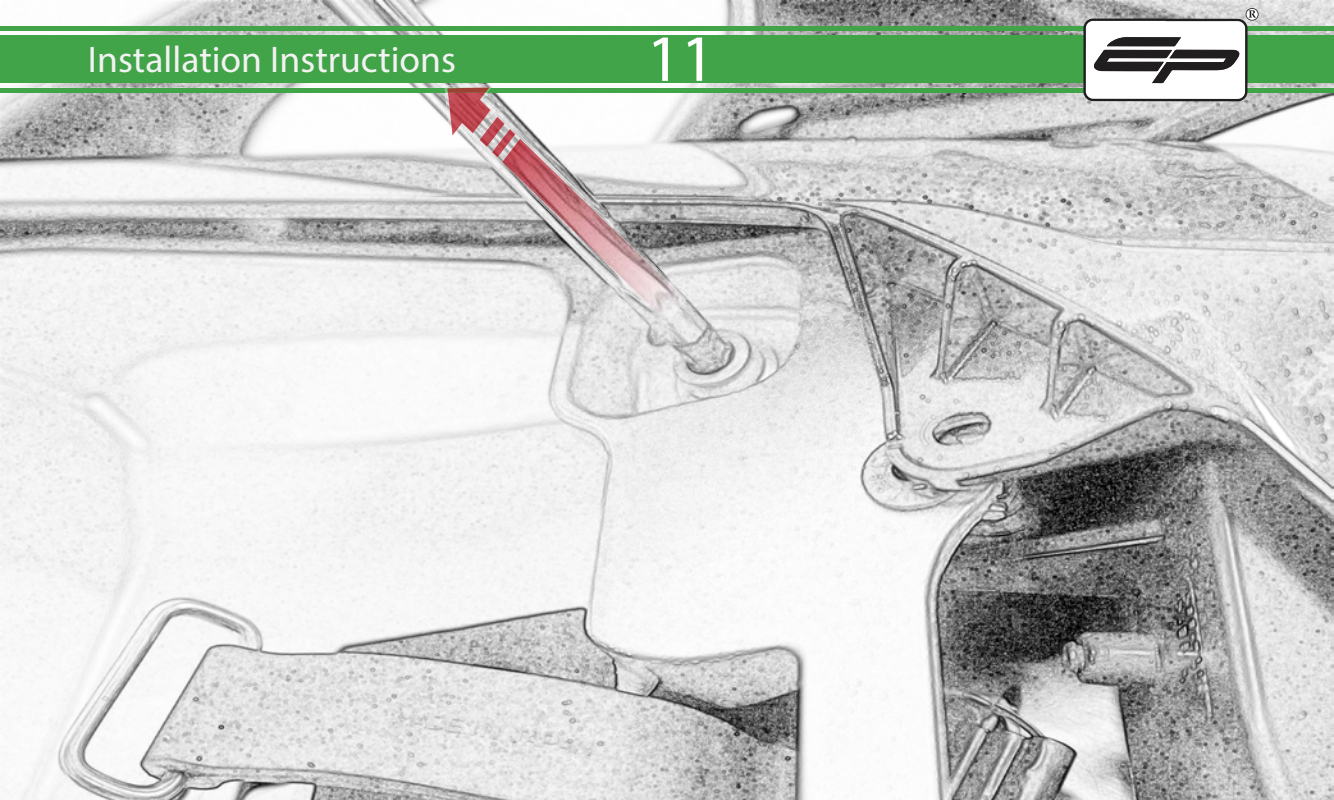

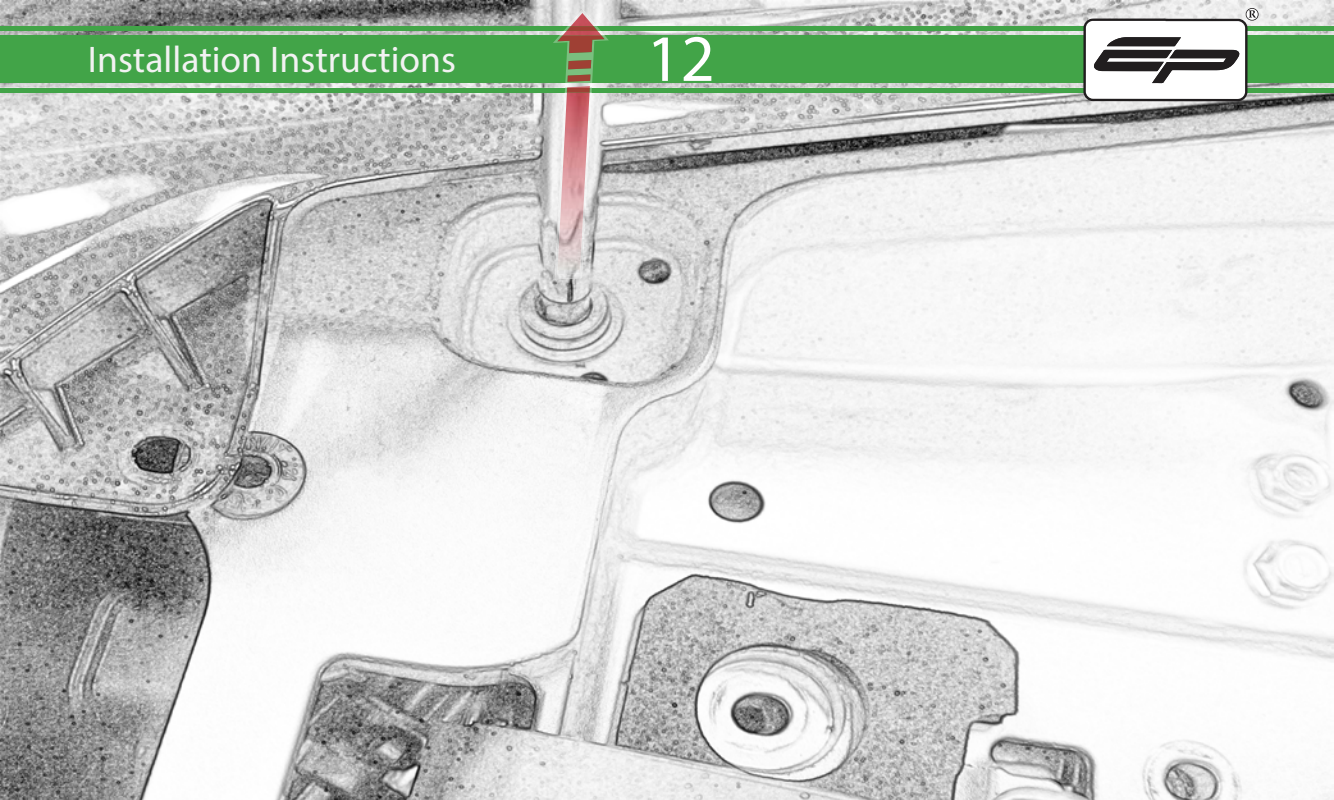

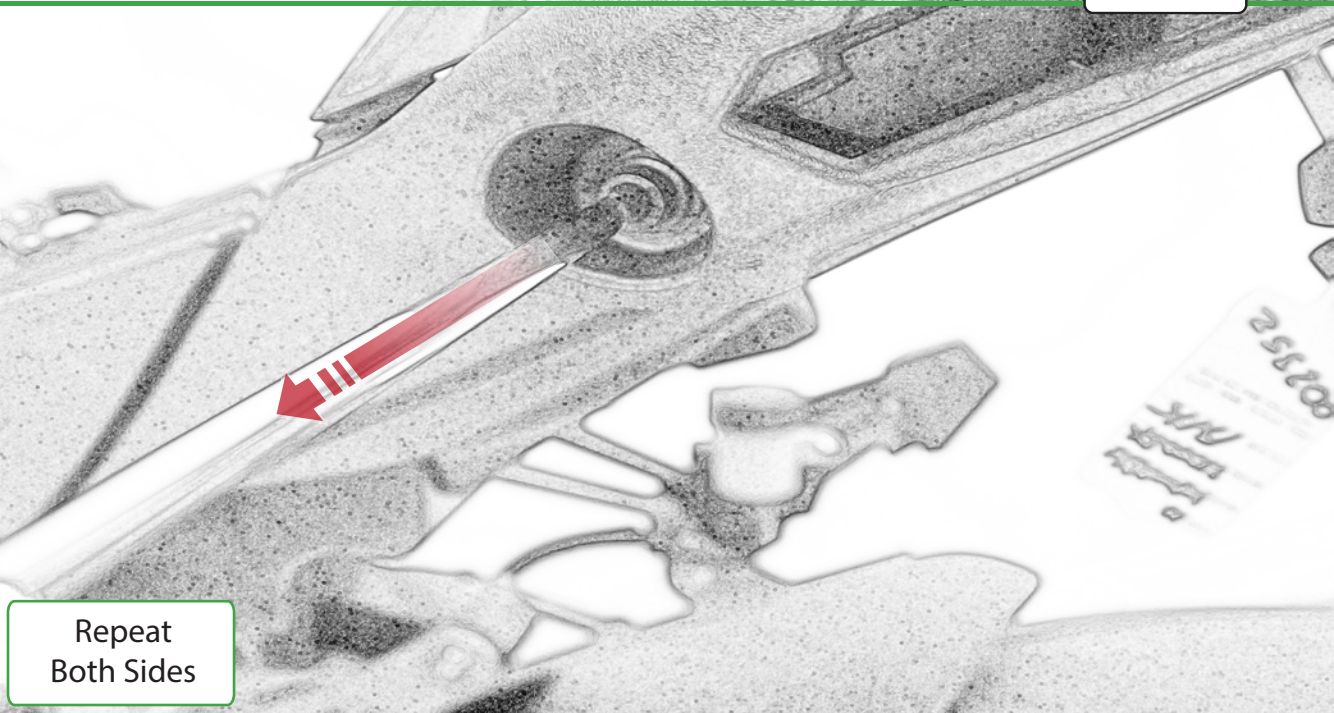

Repeat
Both Sides

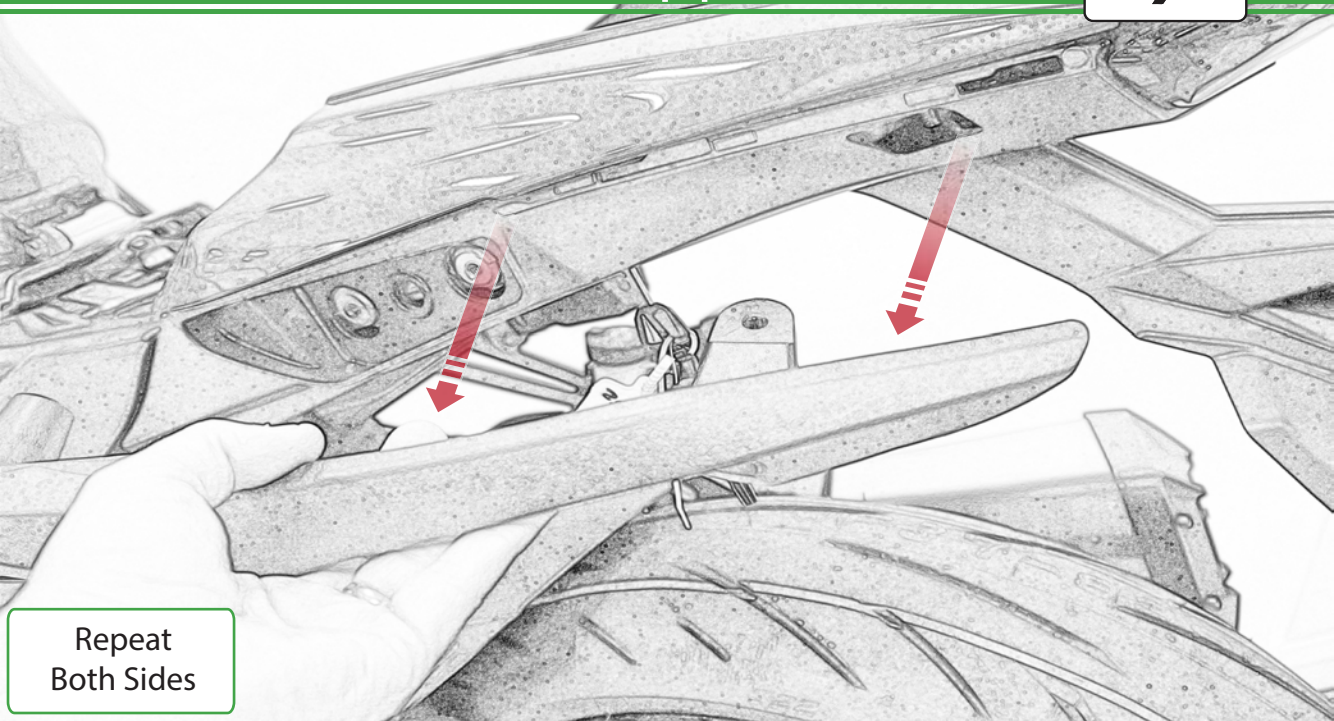

Repeat
Both Sides

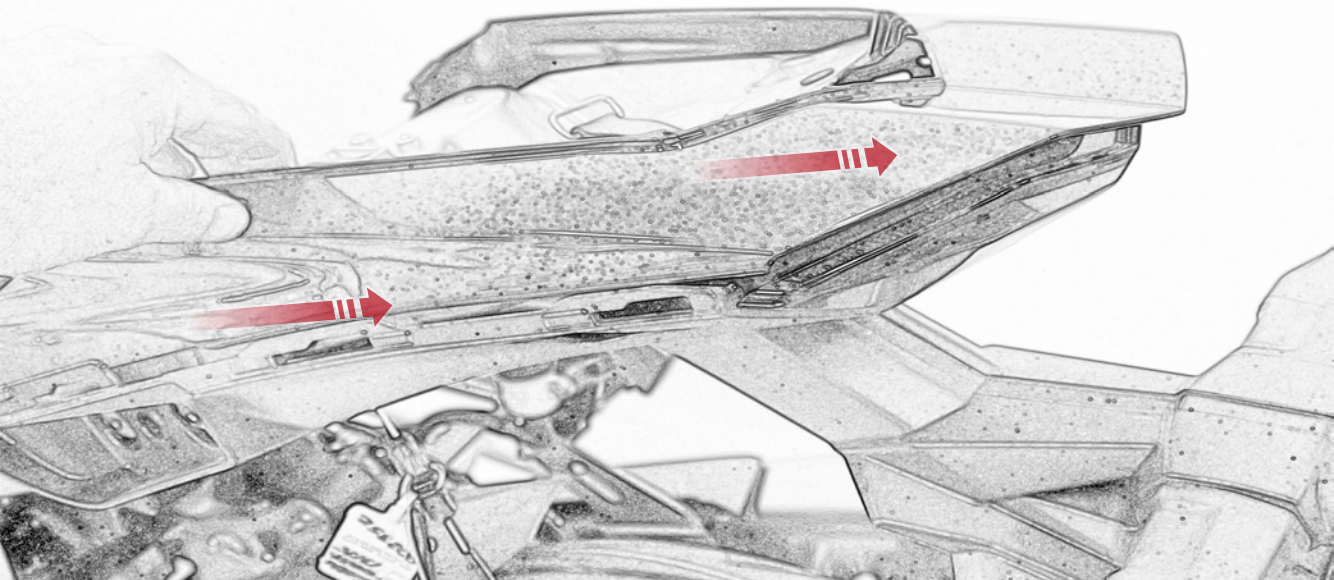

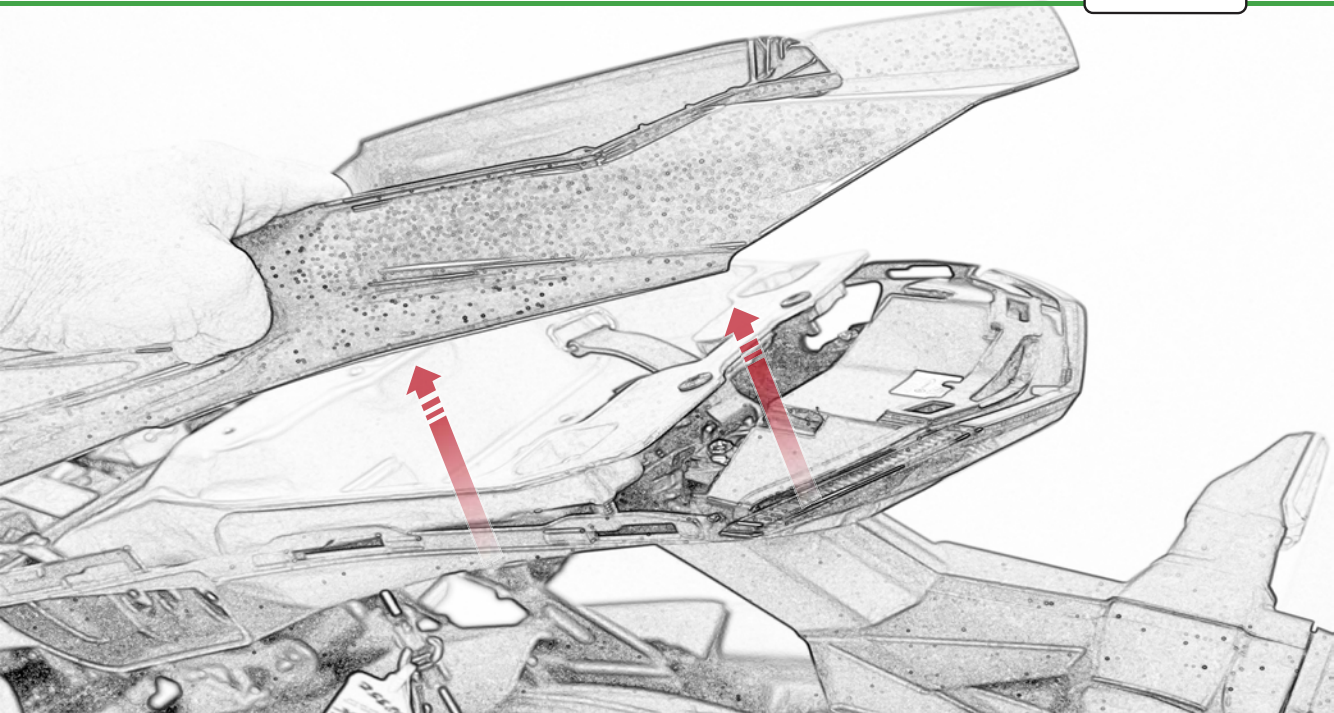

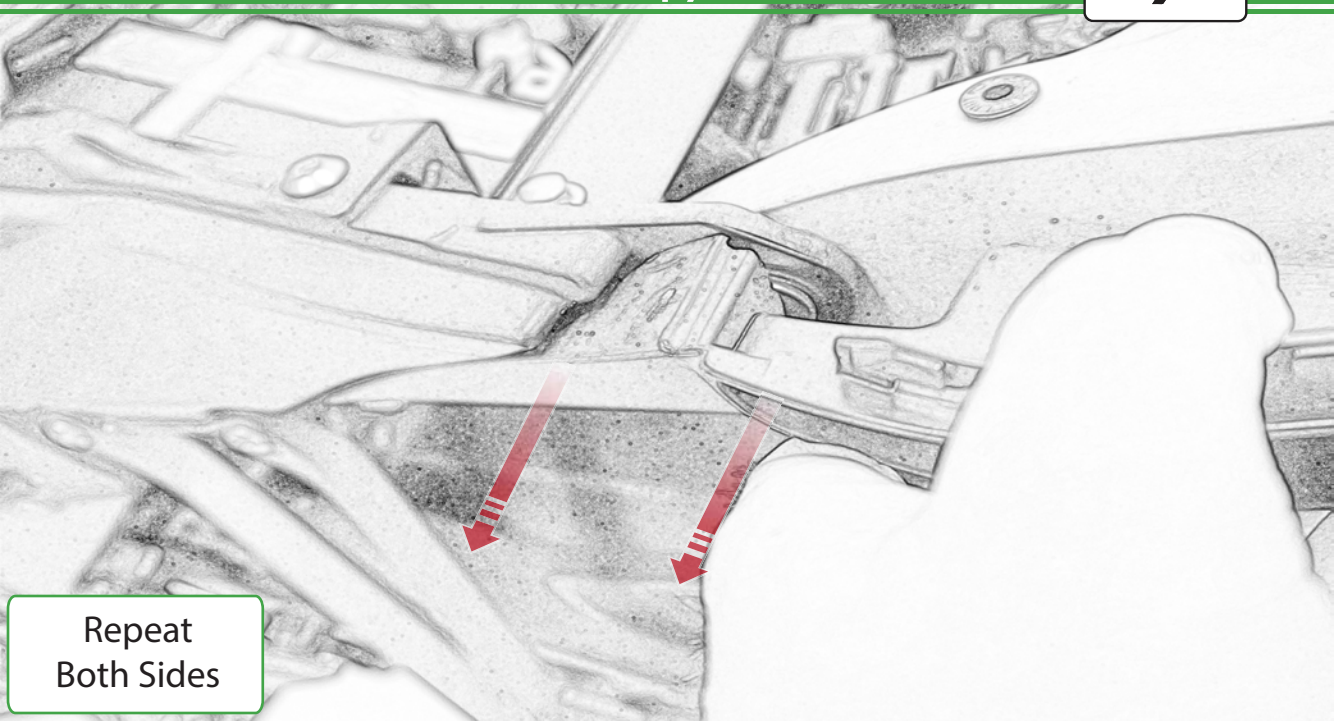

Repeat
Both Sides

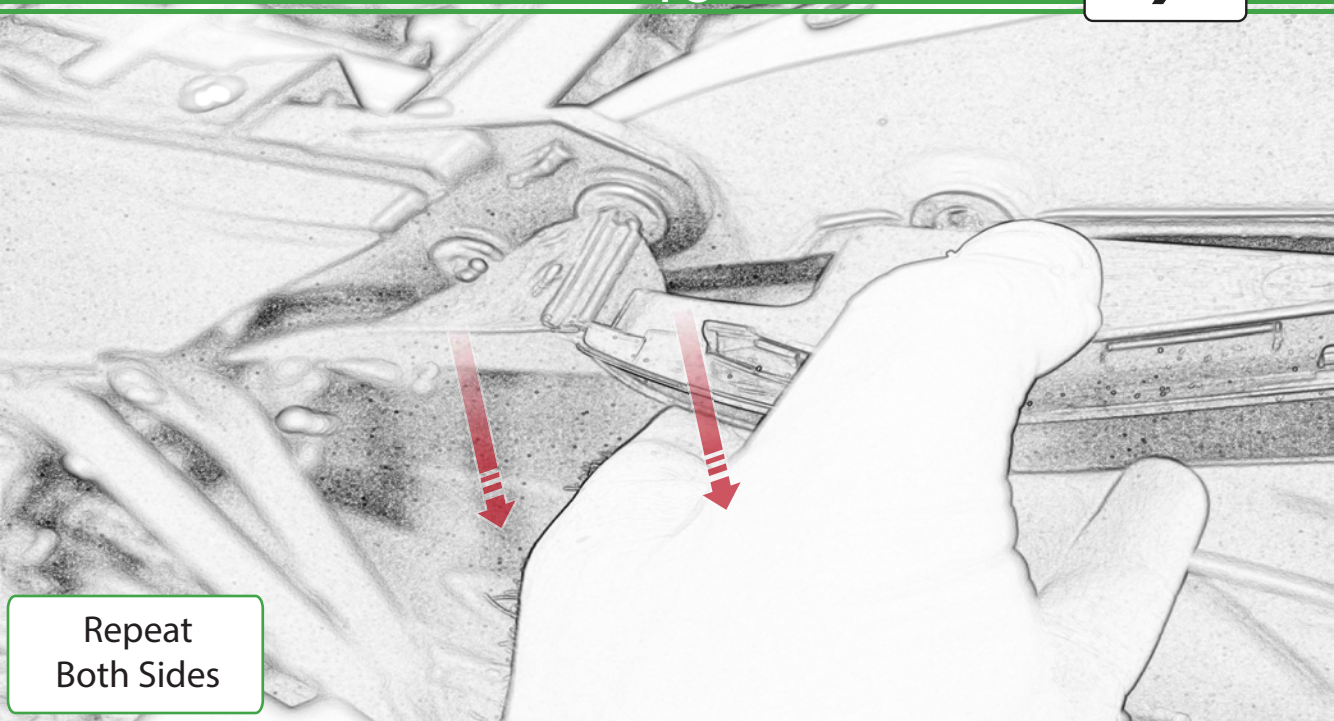

Repeat
Both Sides

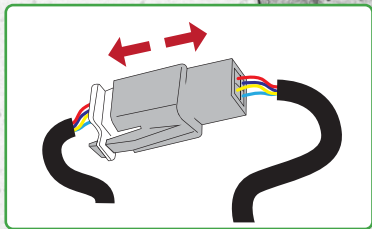
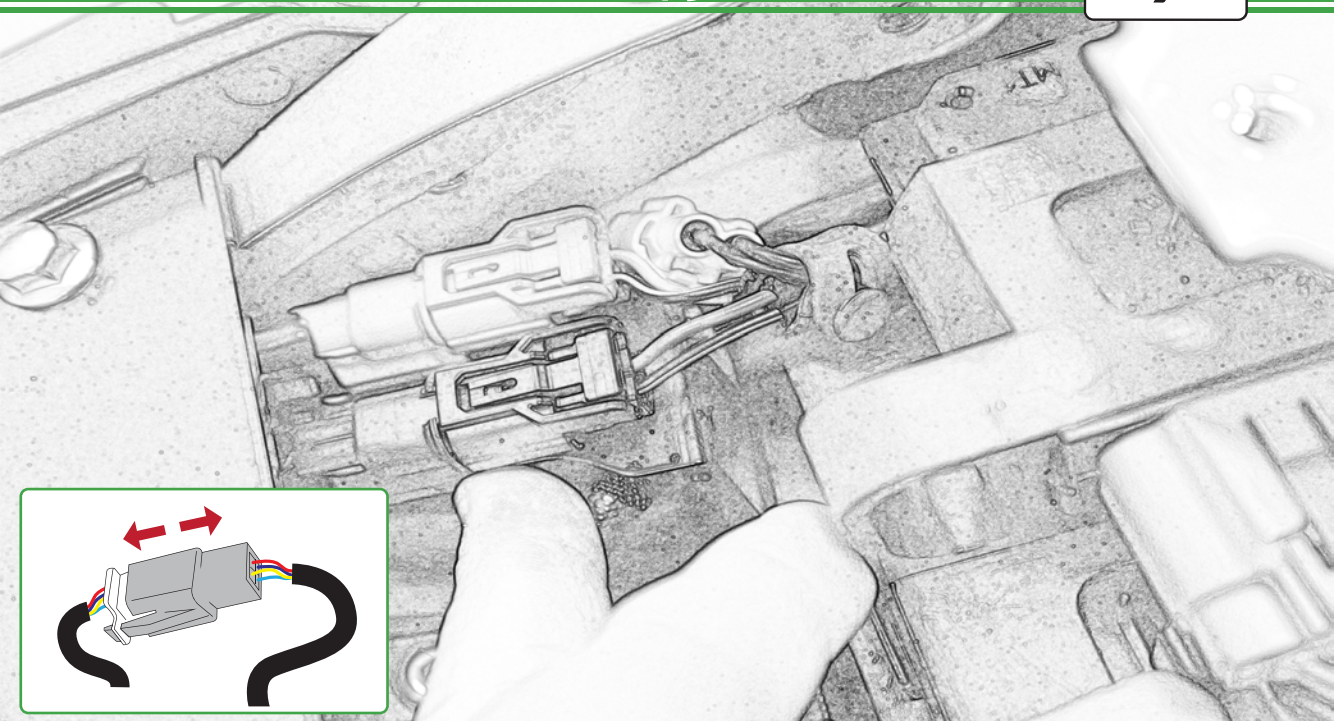

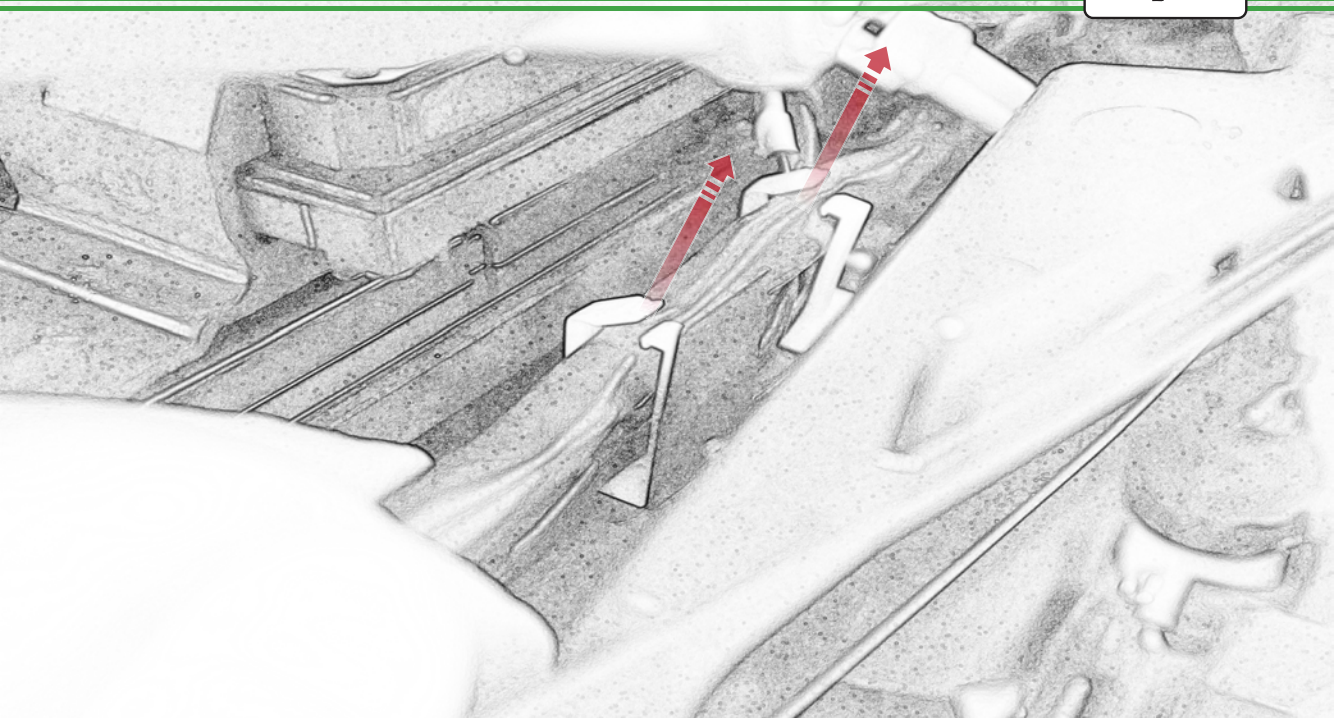

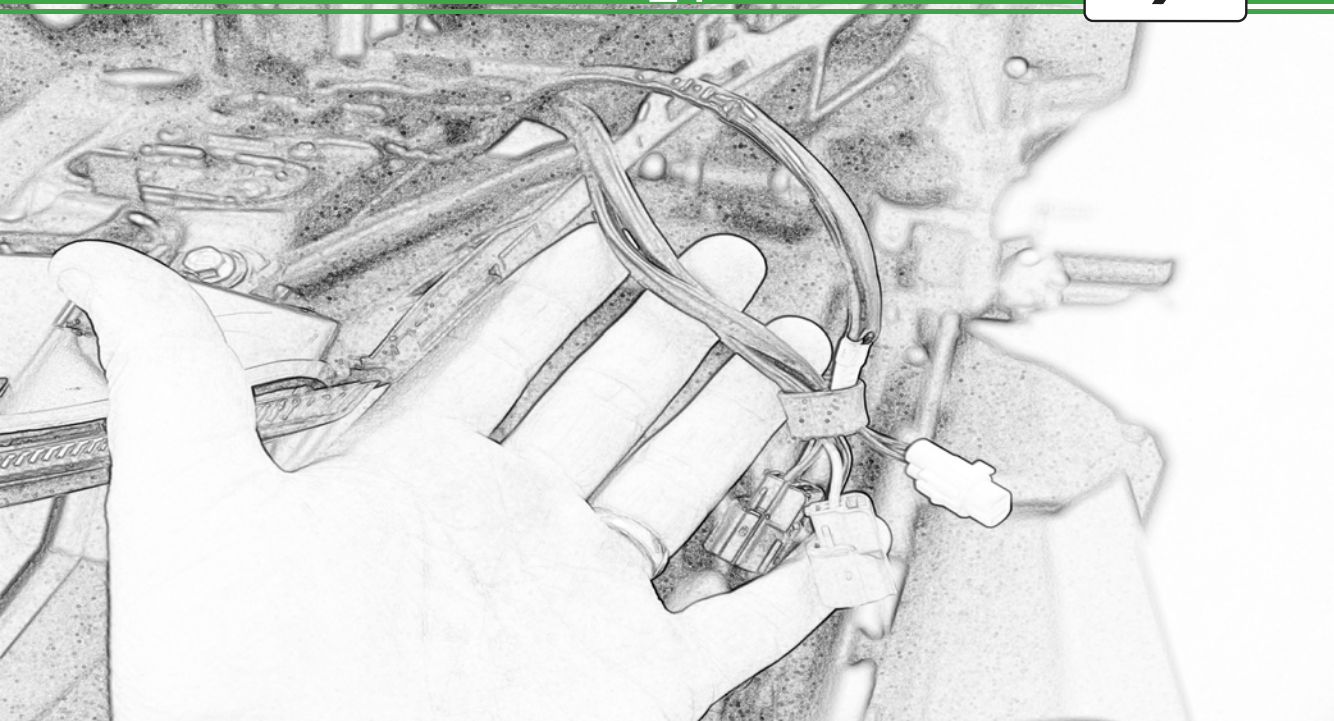

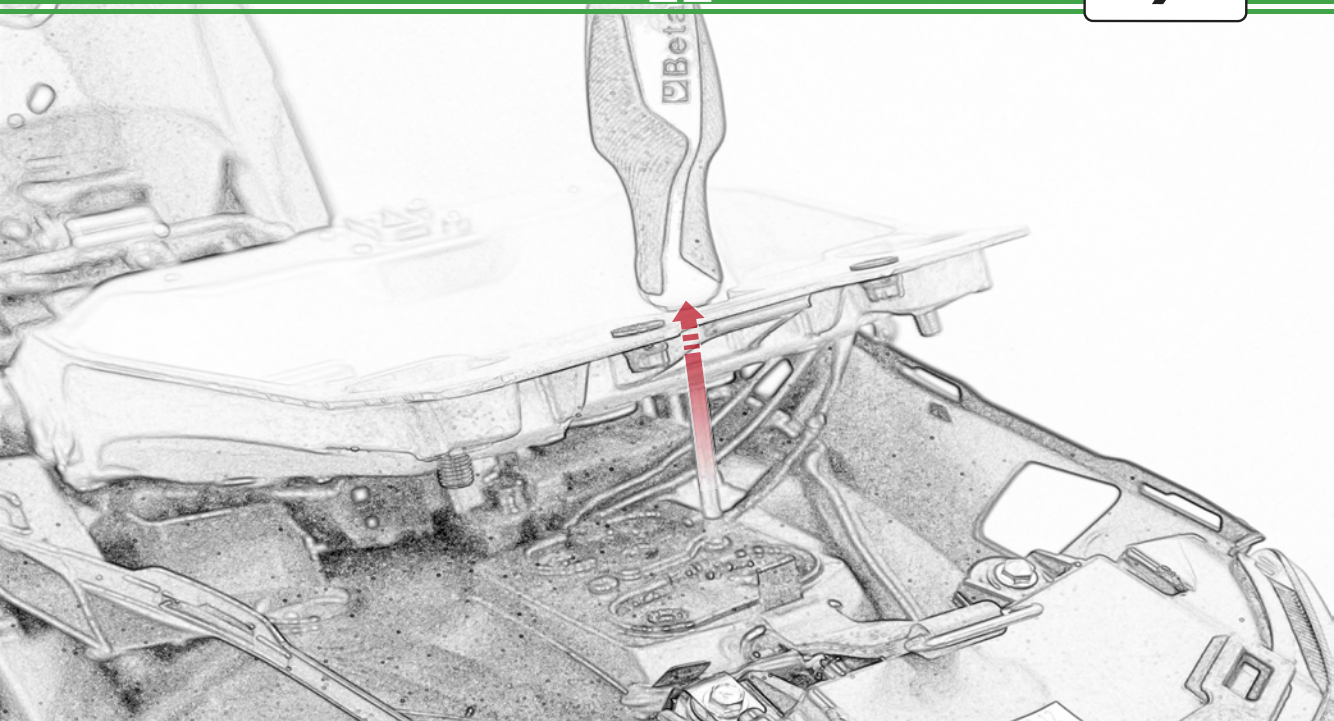

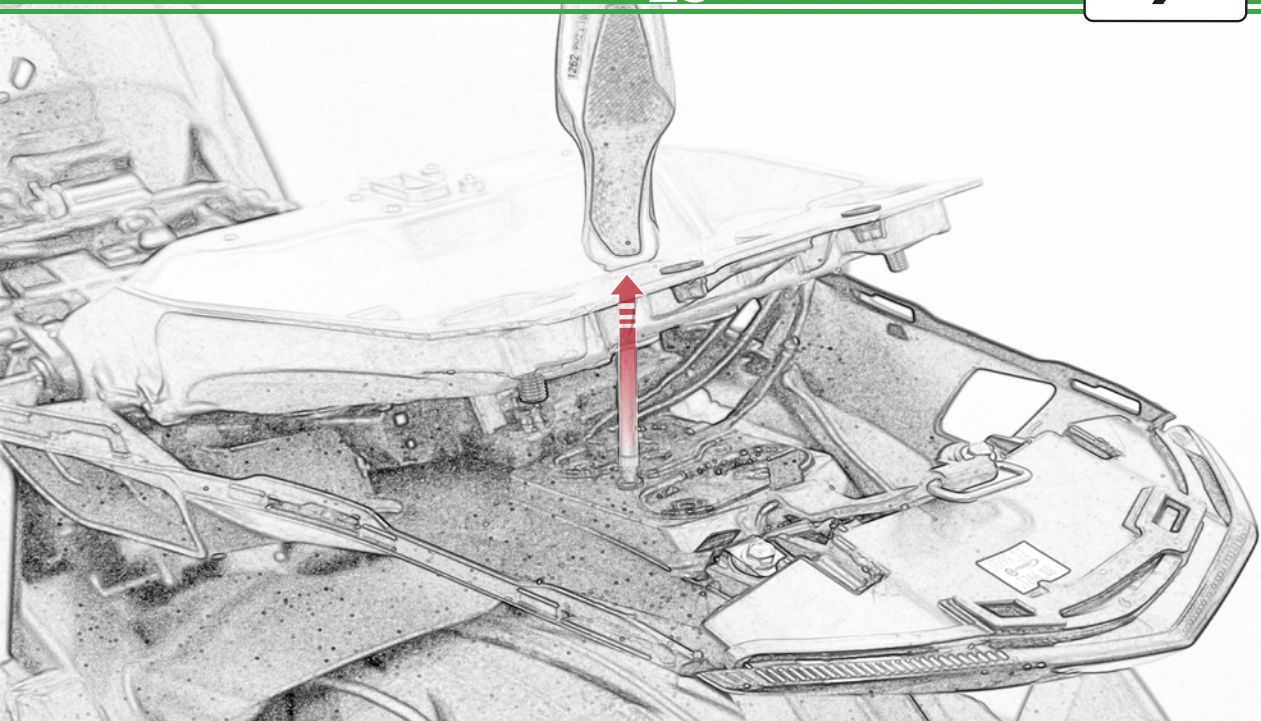

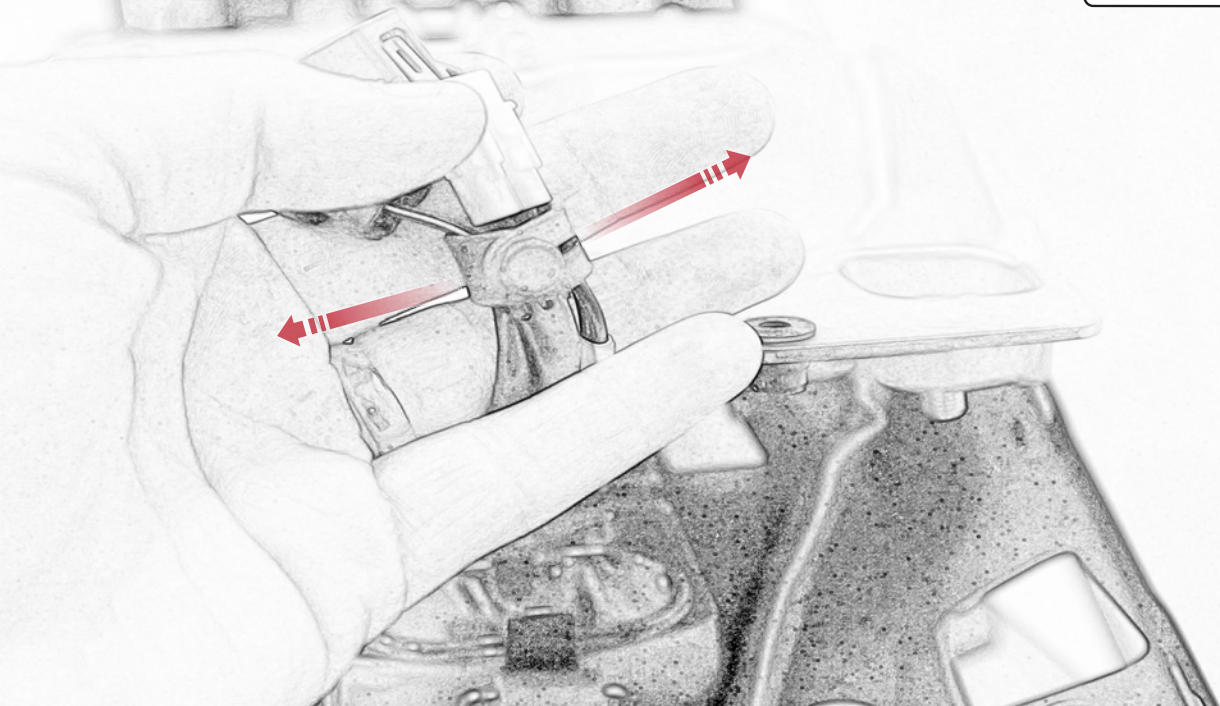

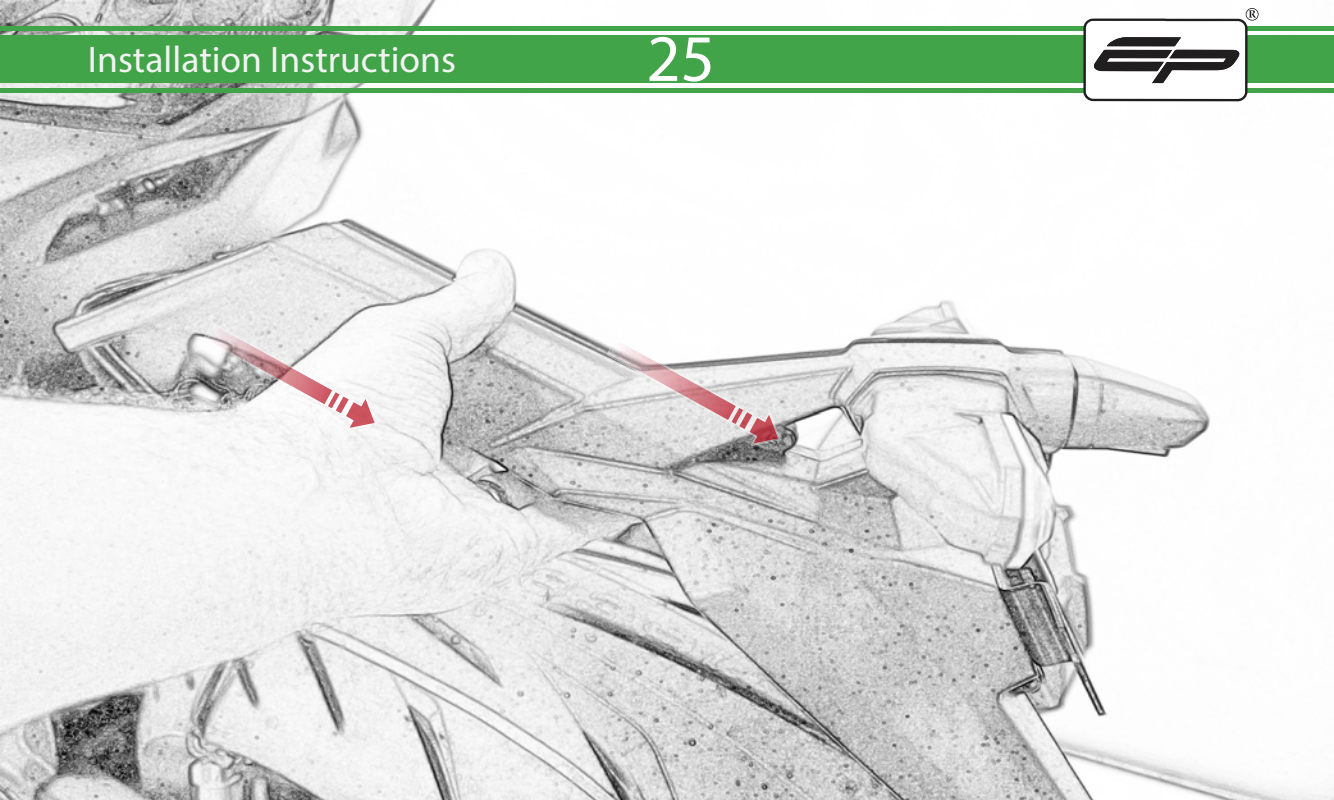

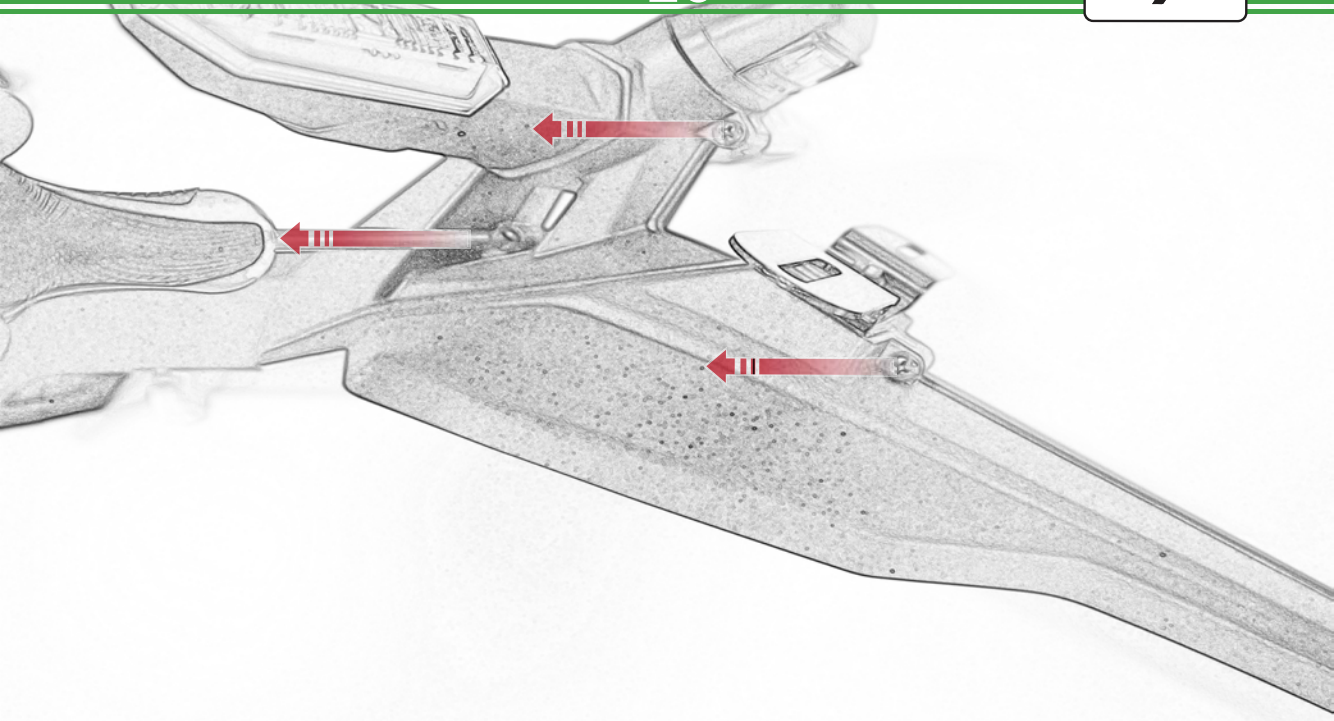

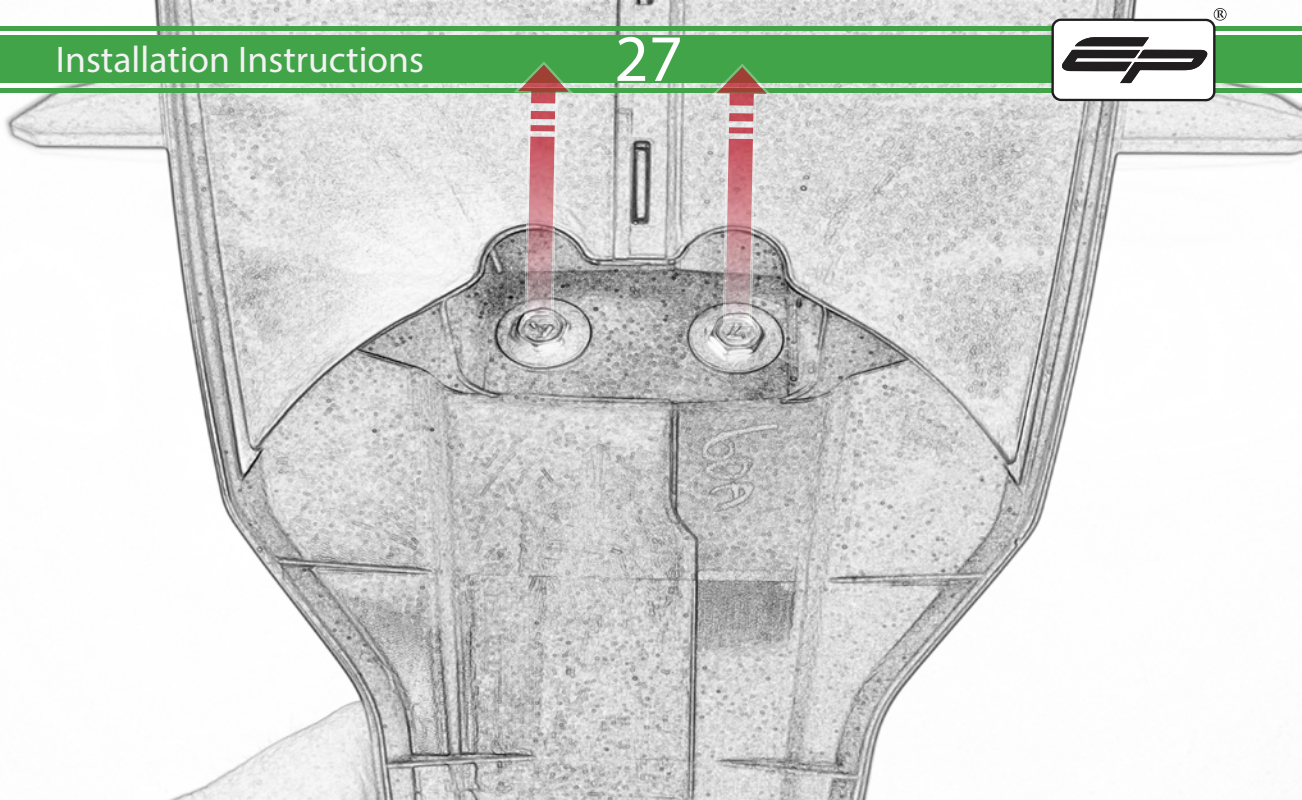

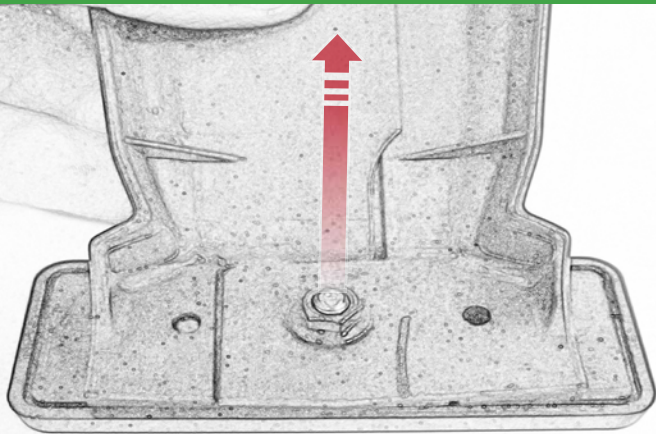

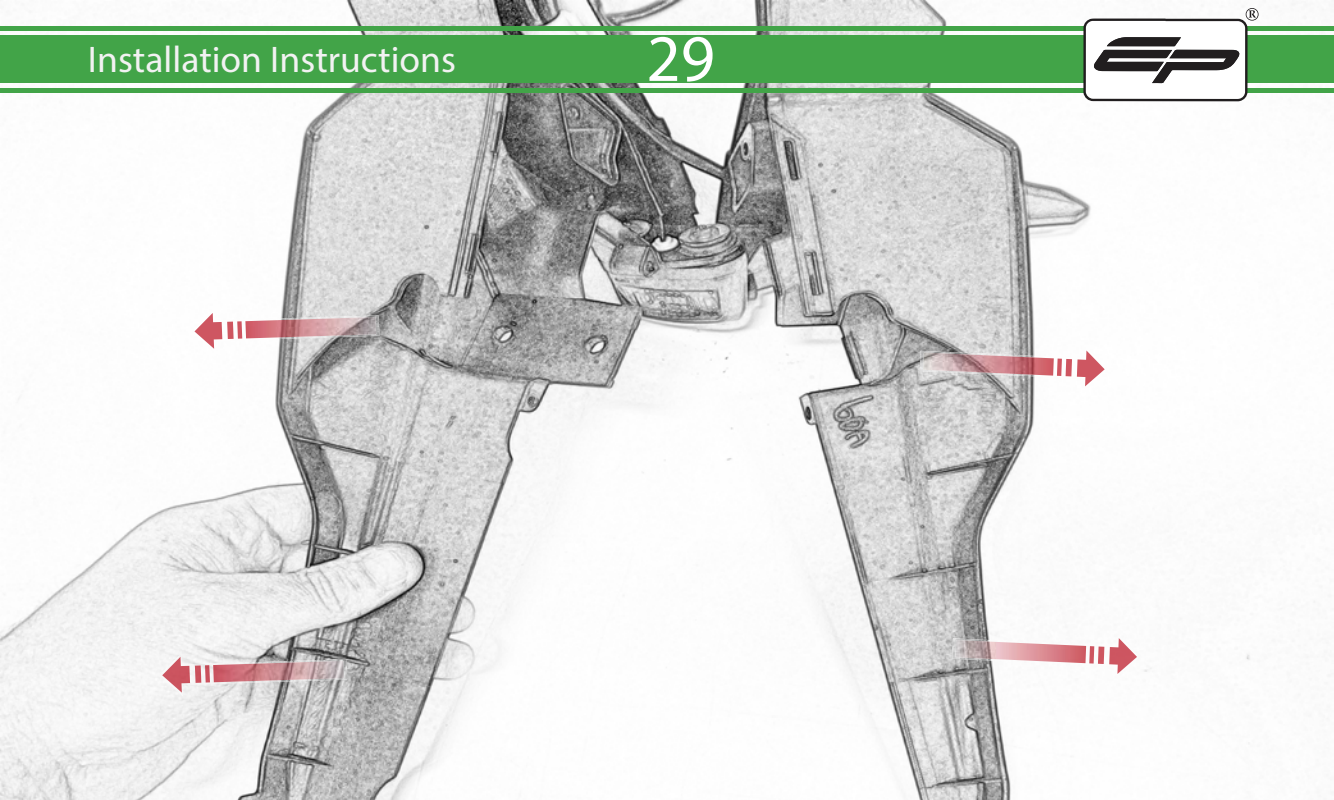

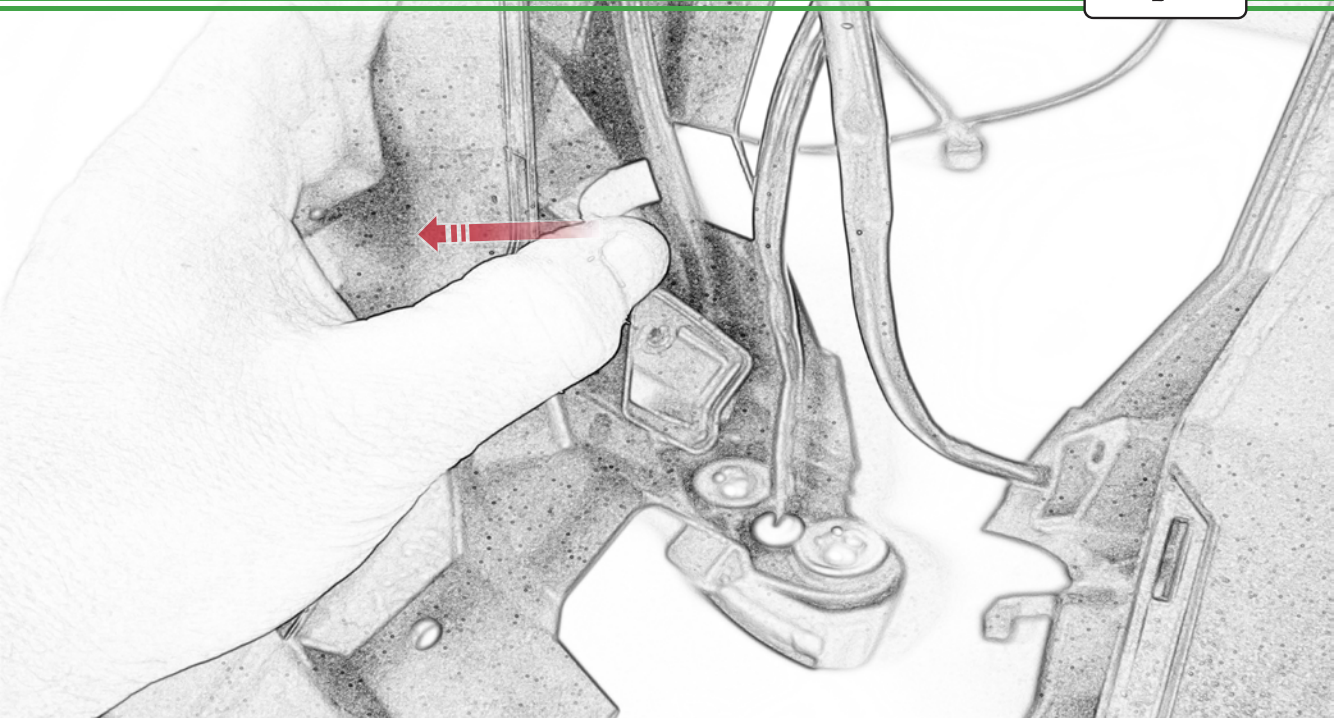

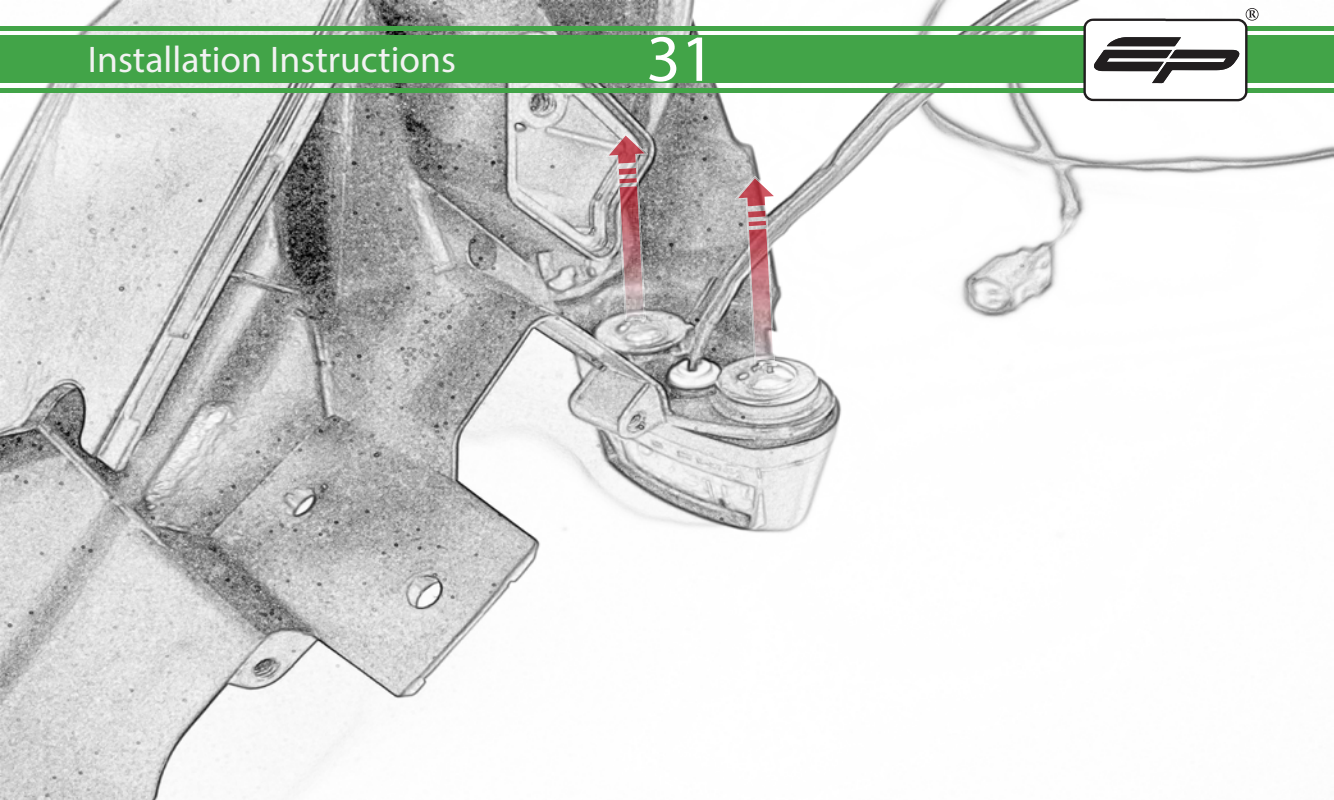

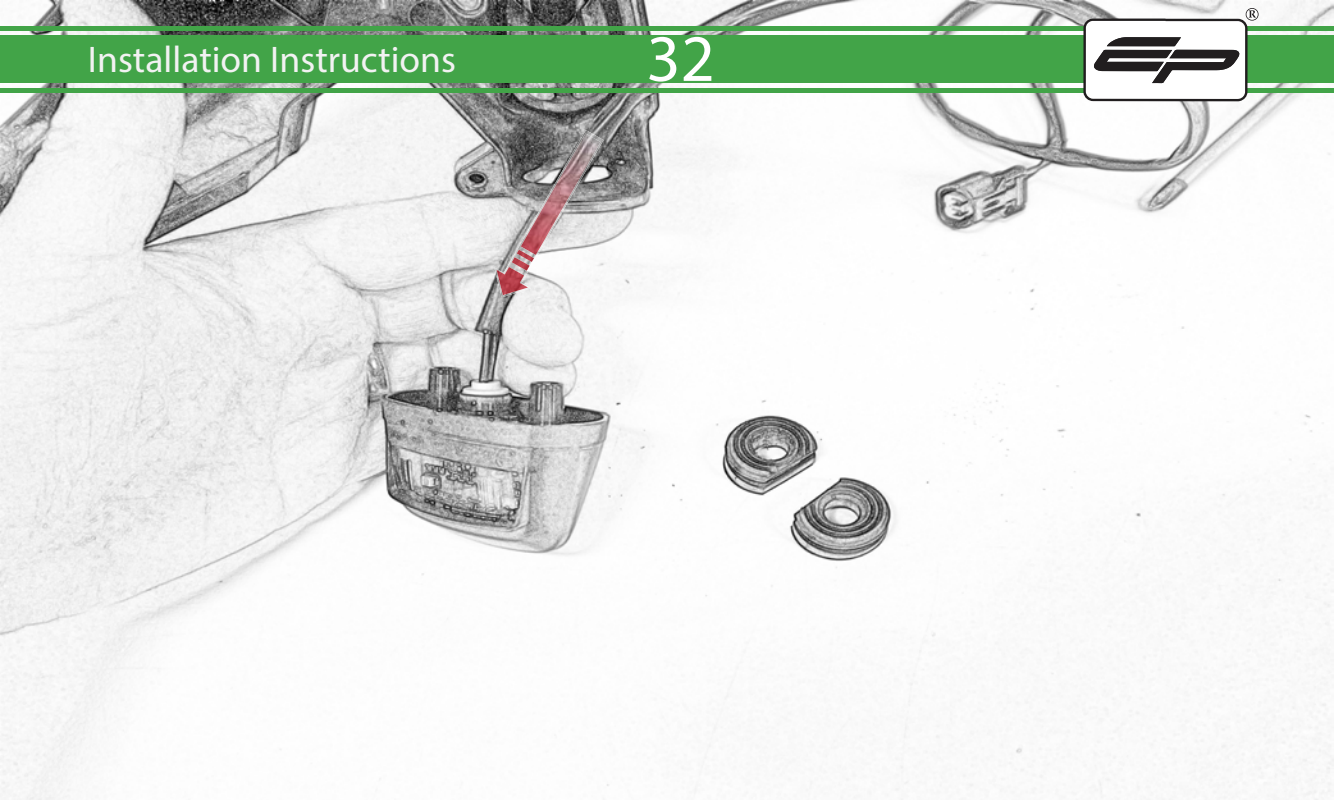

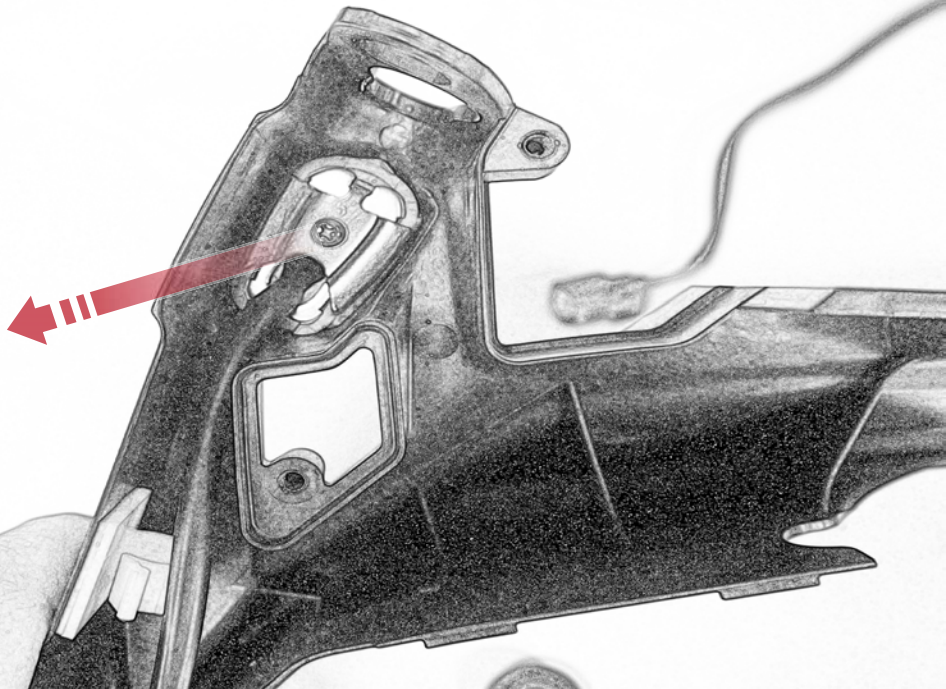

Repeat
Both Sides

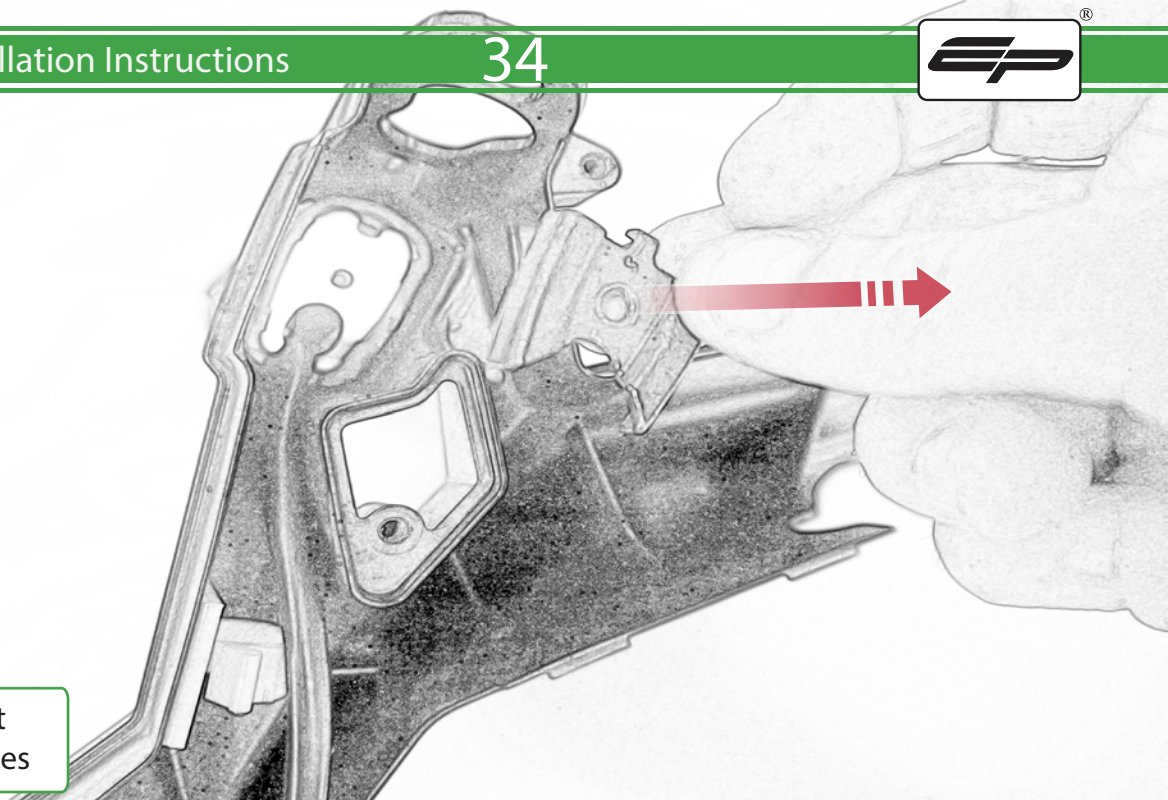

Repeat
Both Sides

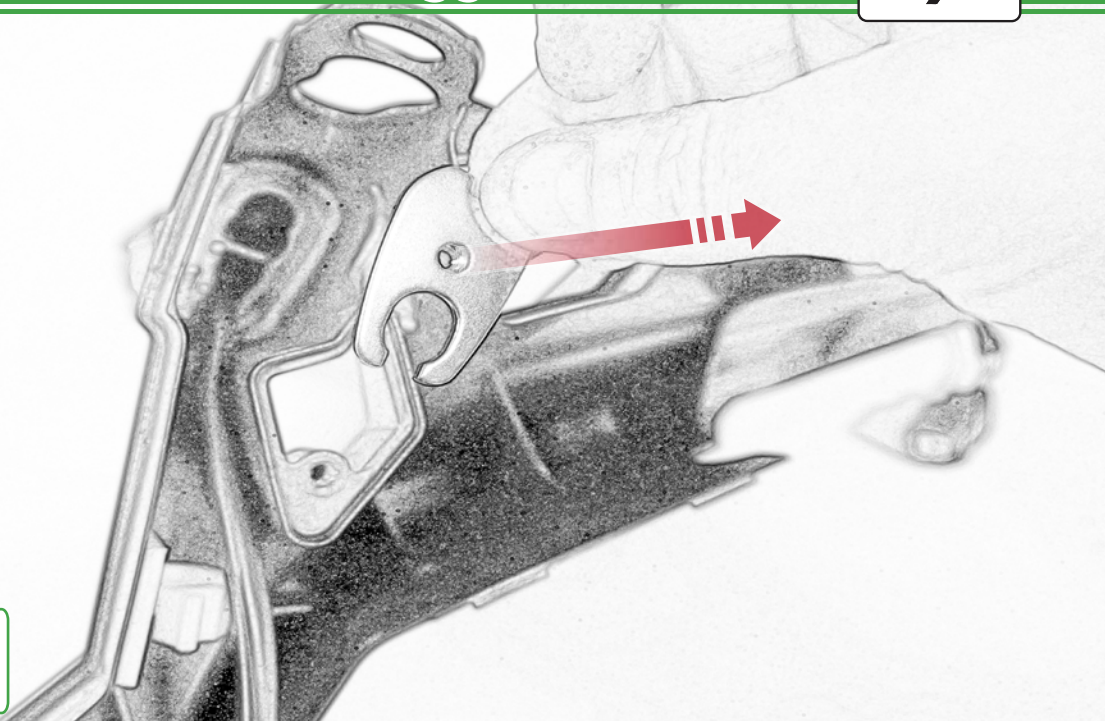

Repeat
Both Sides

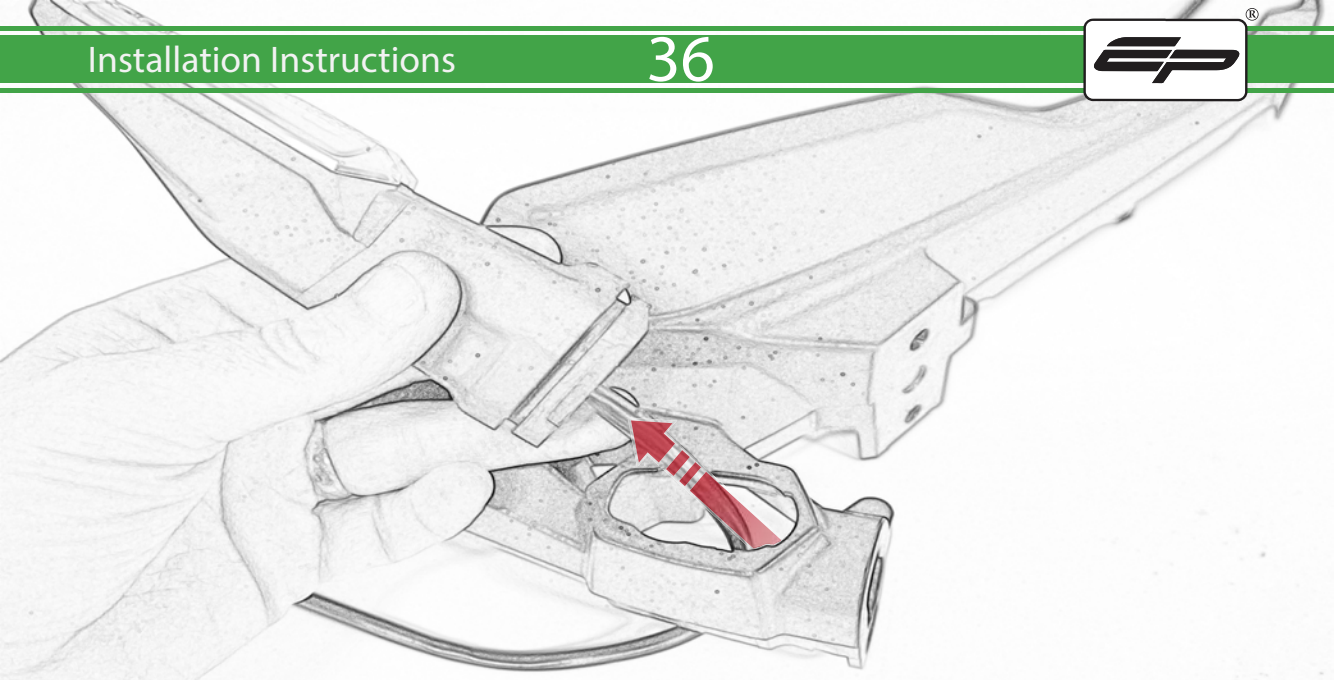

Repeat
Both Sides

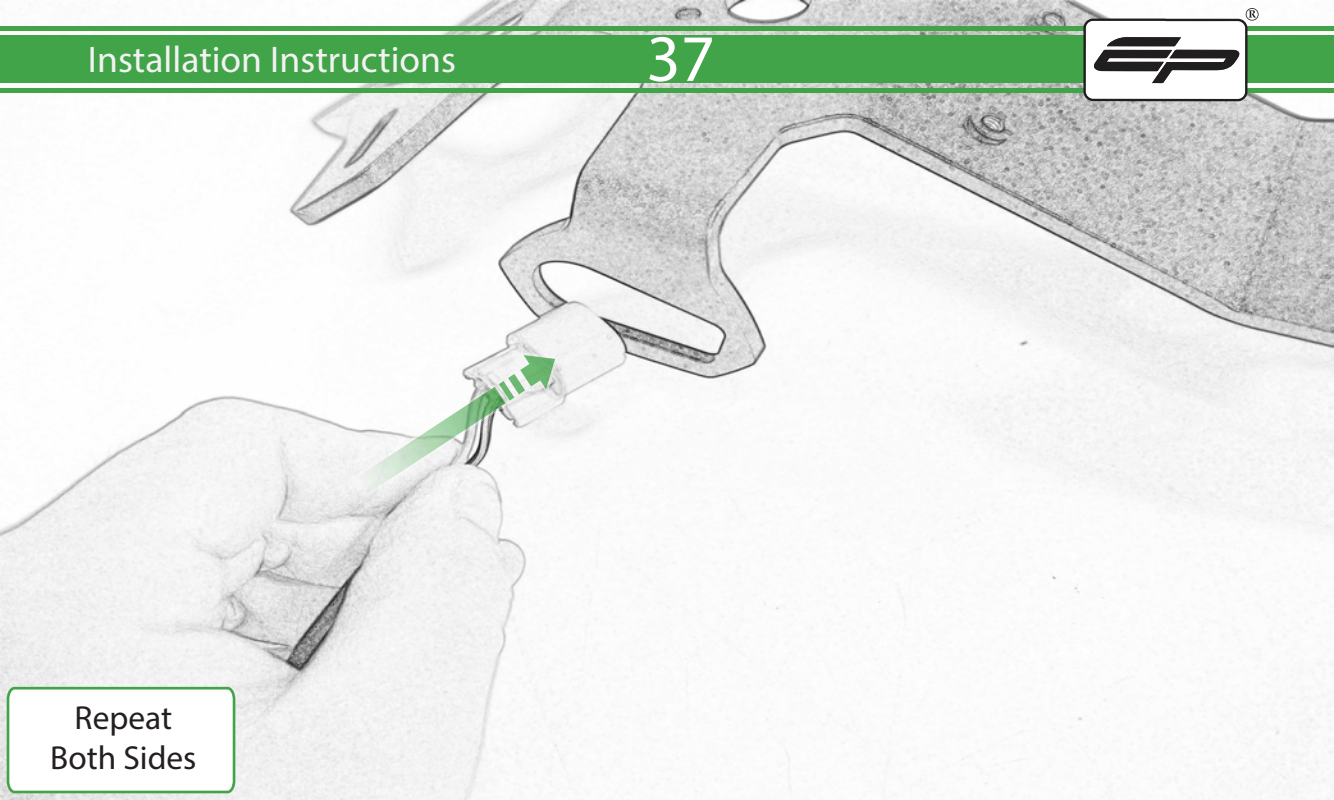

Repeat
Both Sides

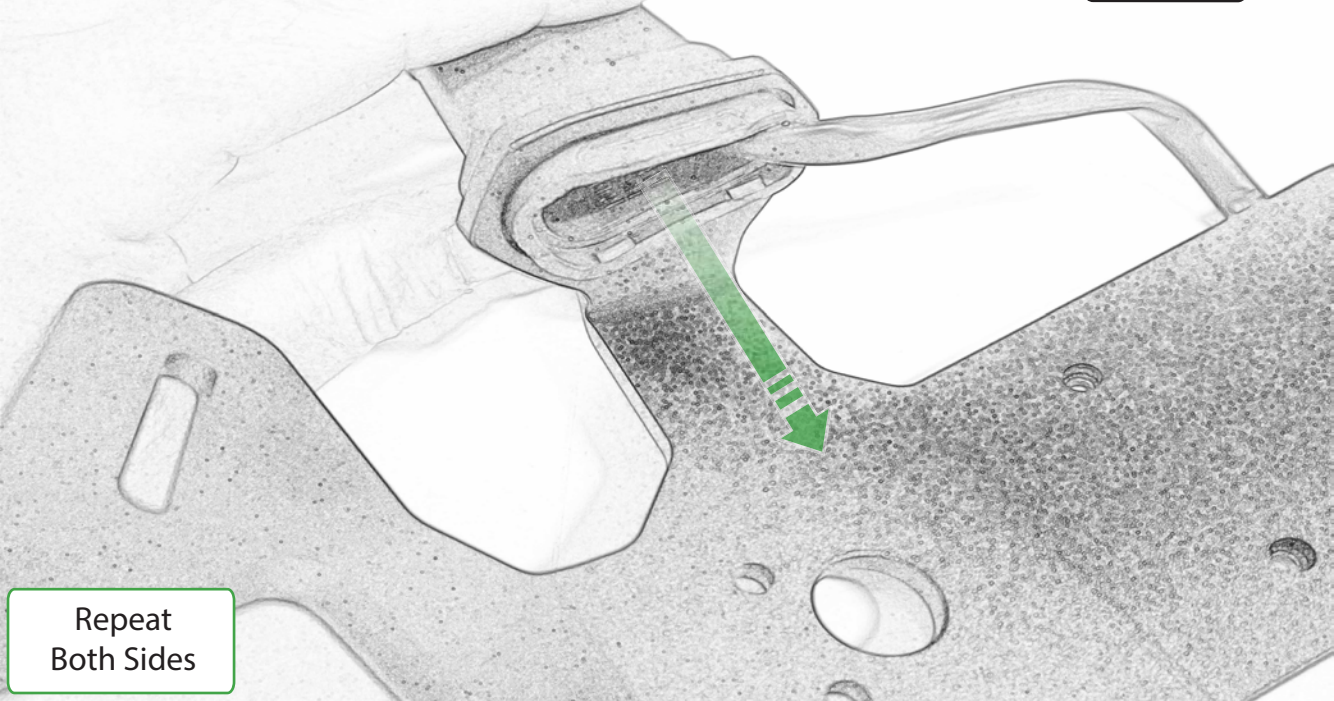

Repeat
Both Sides

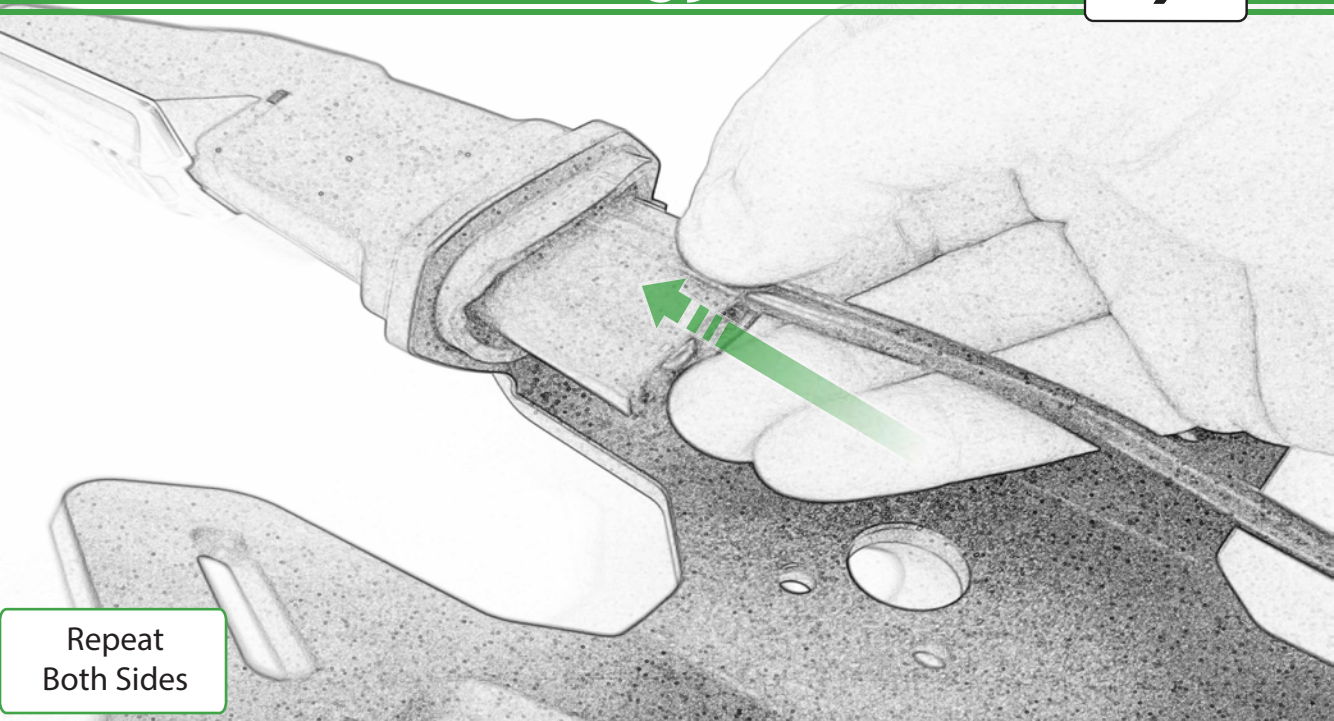

Repeat
Both Sides

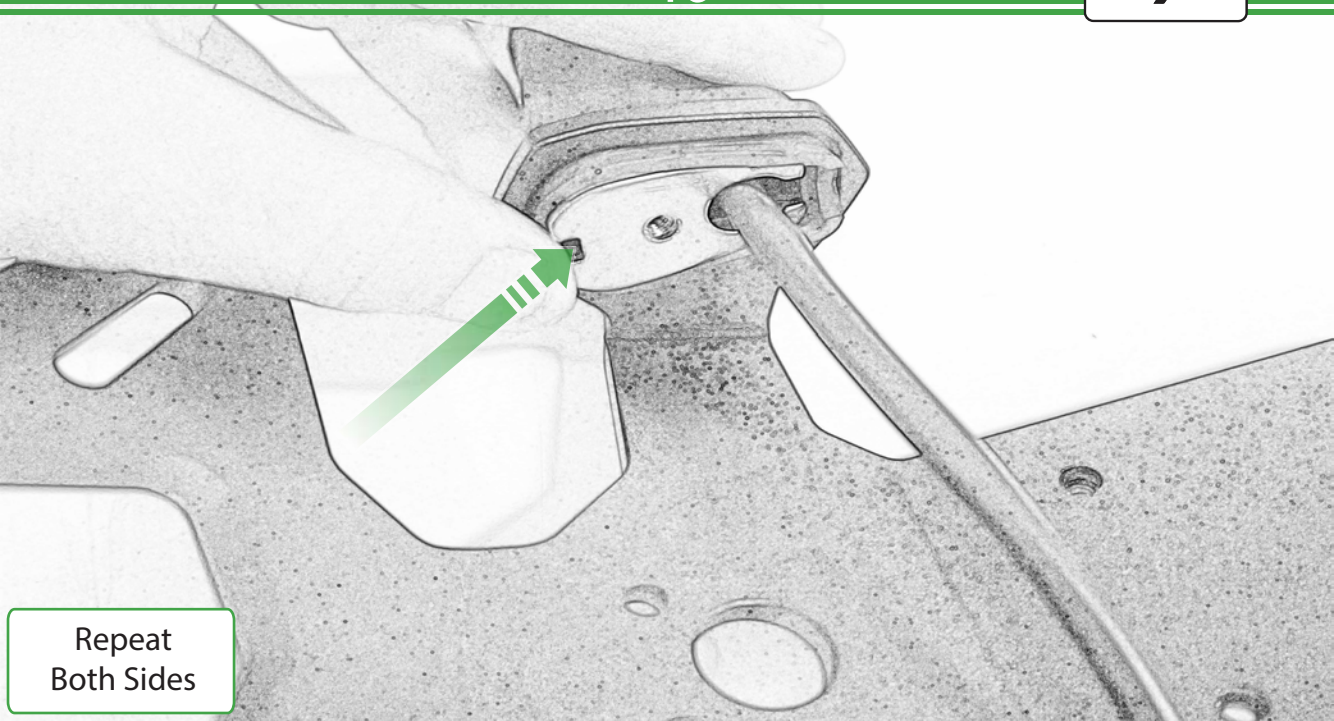

Repeat
Both Sides

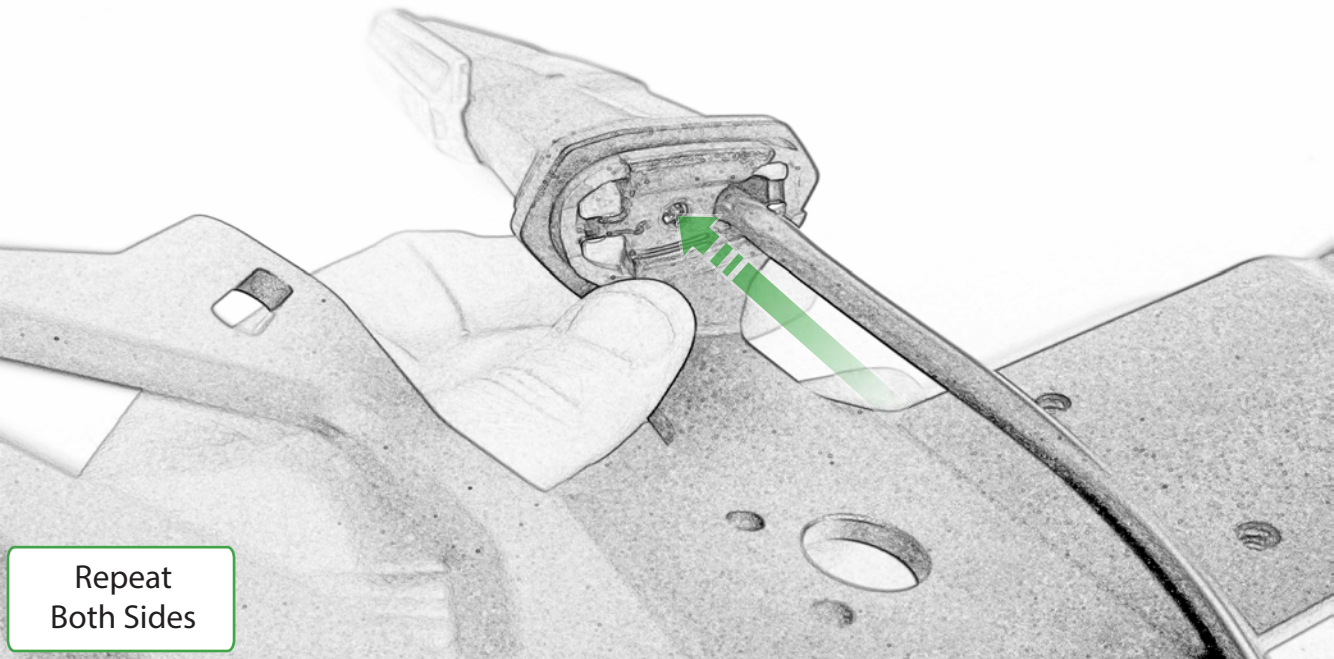

Repeat
Both Sides

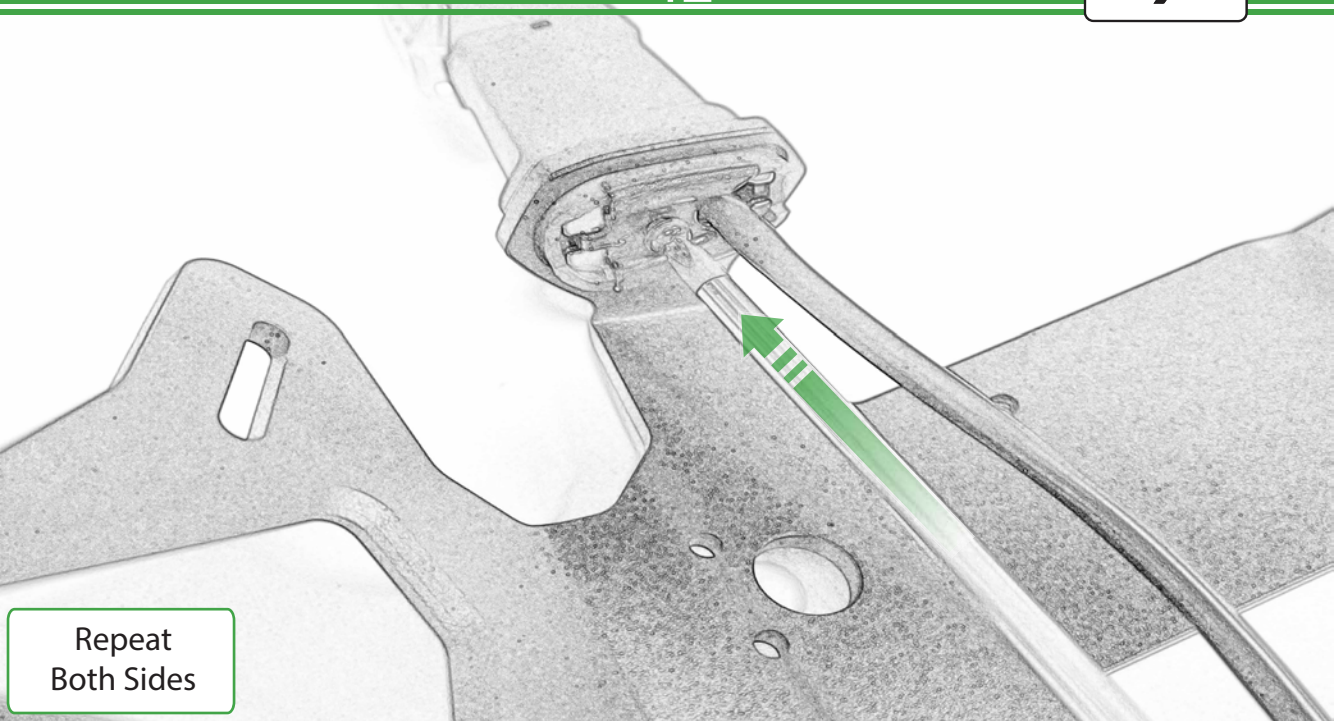

Repeat
Both Sides

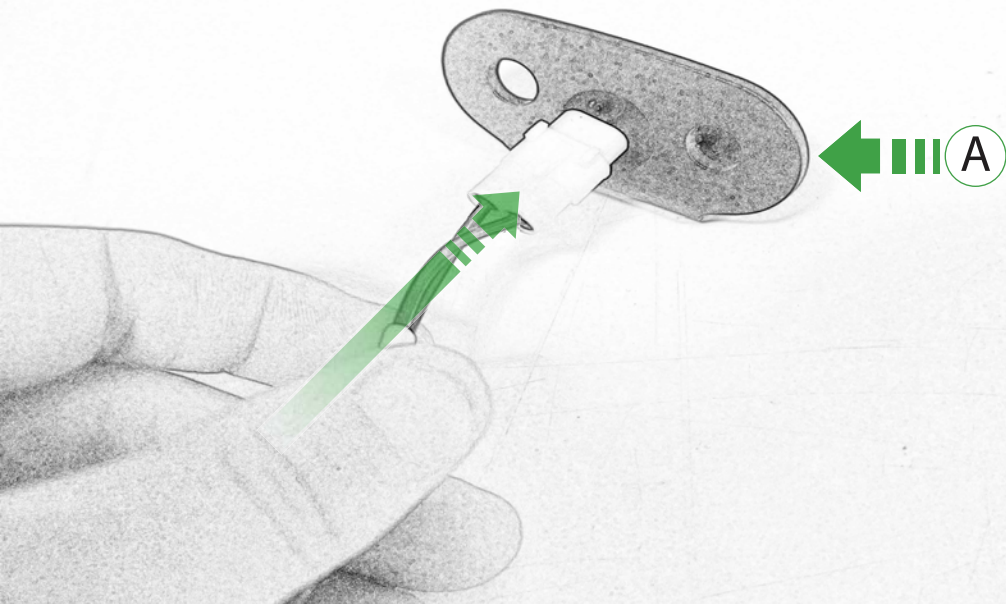

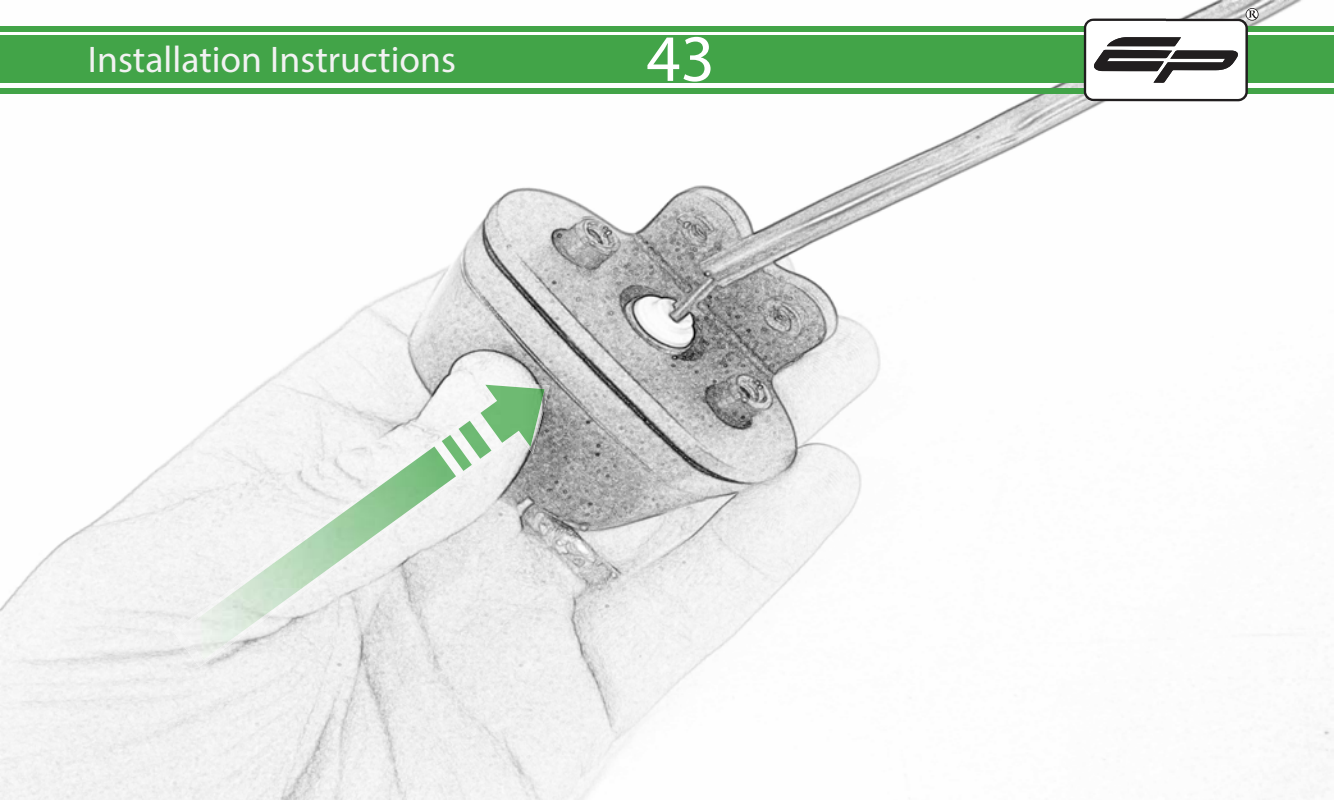

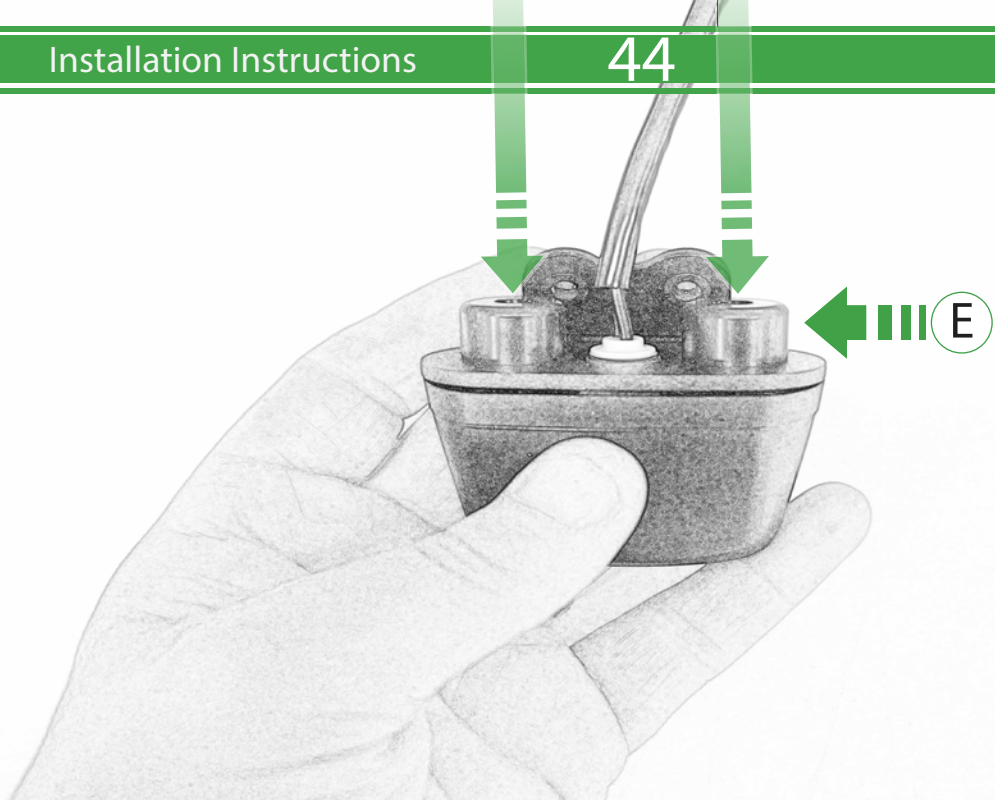



OEM PART

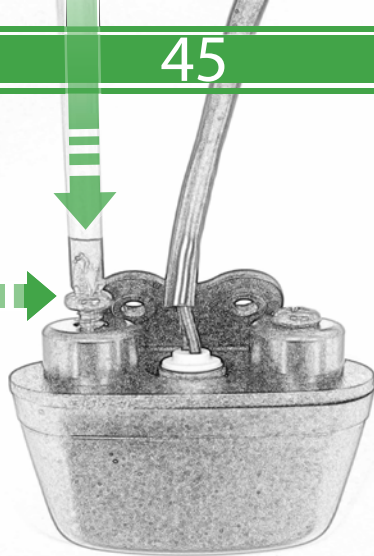

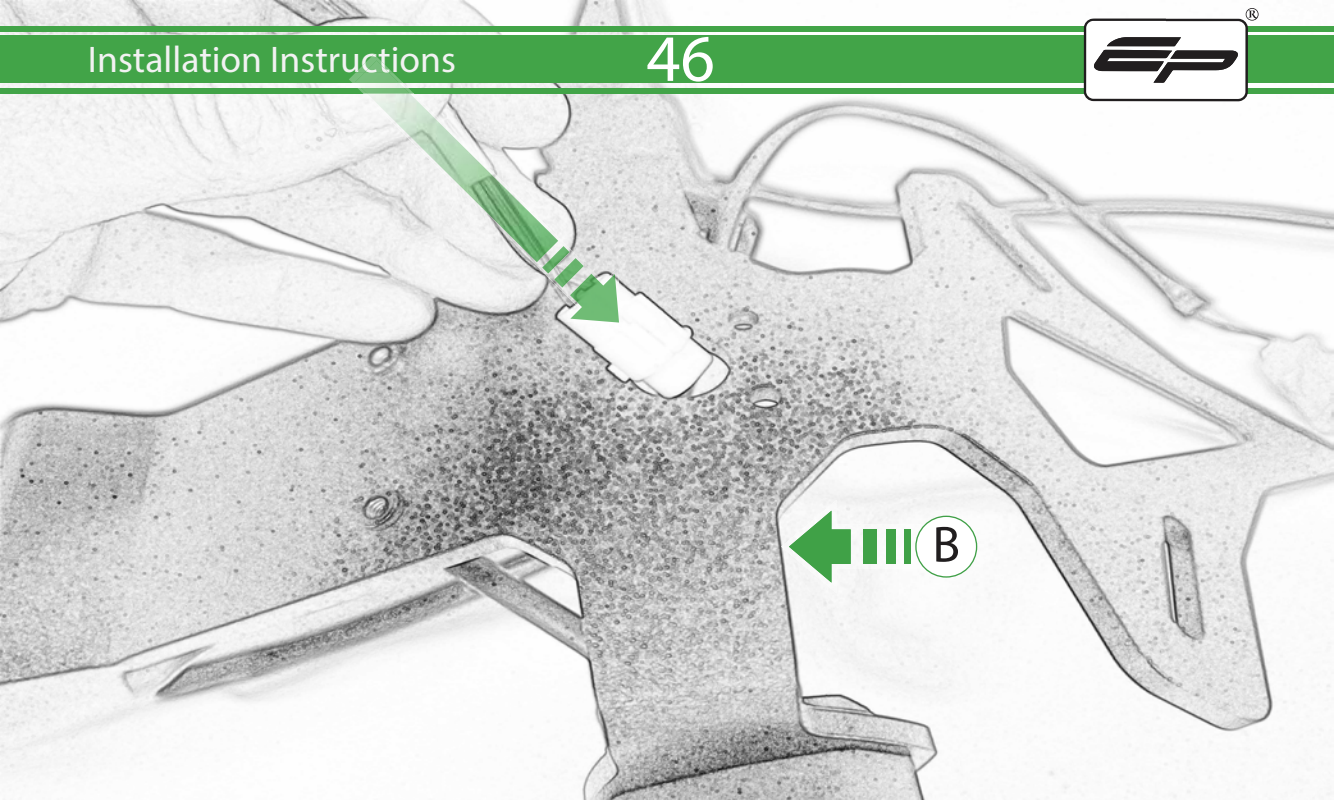

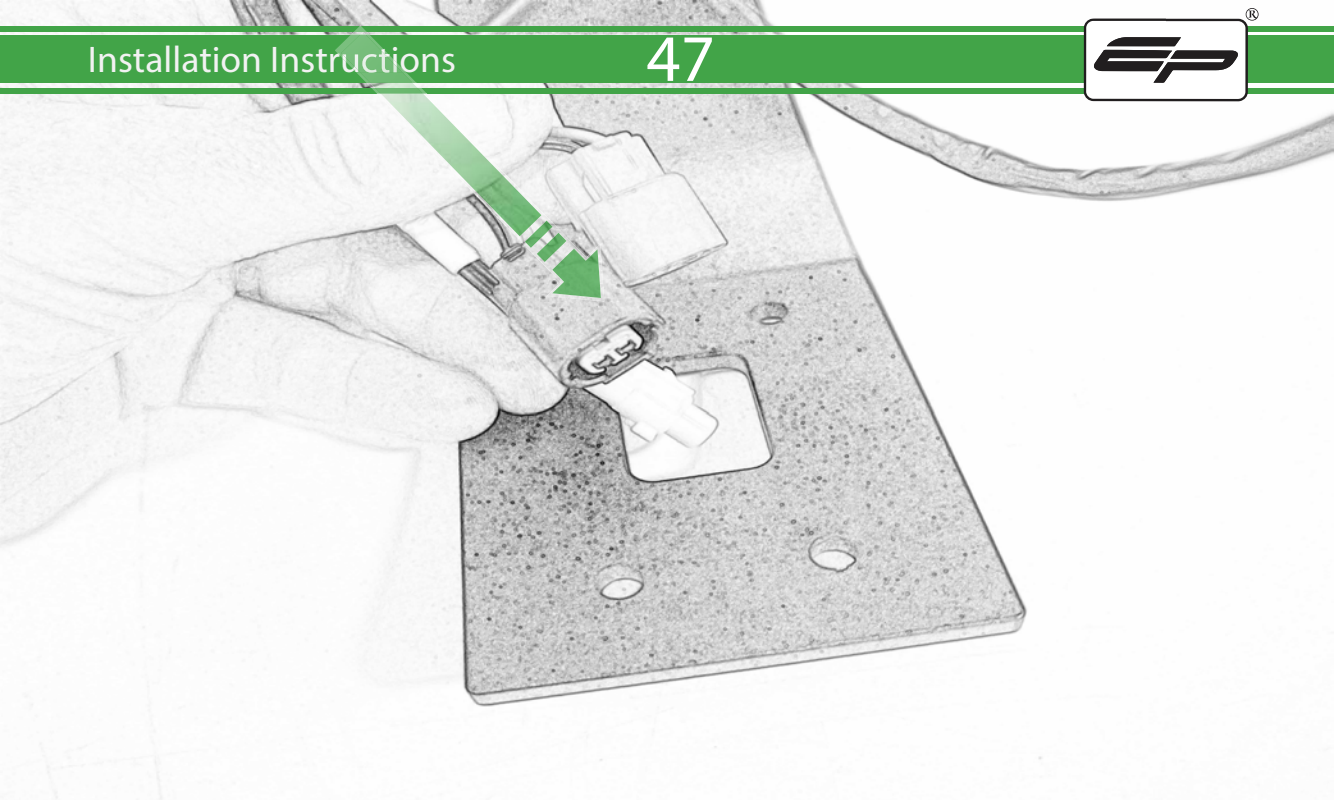

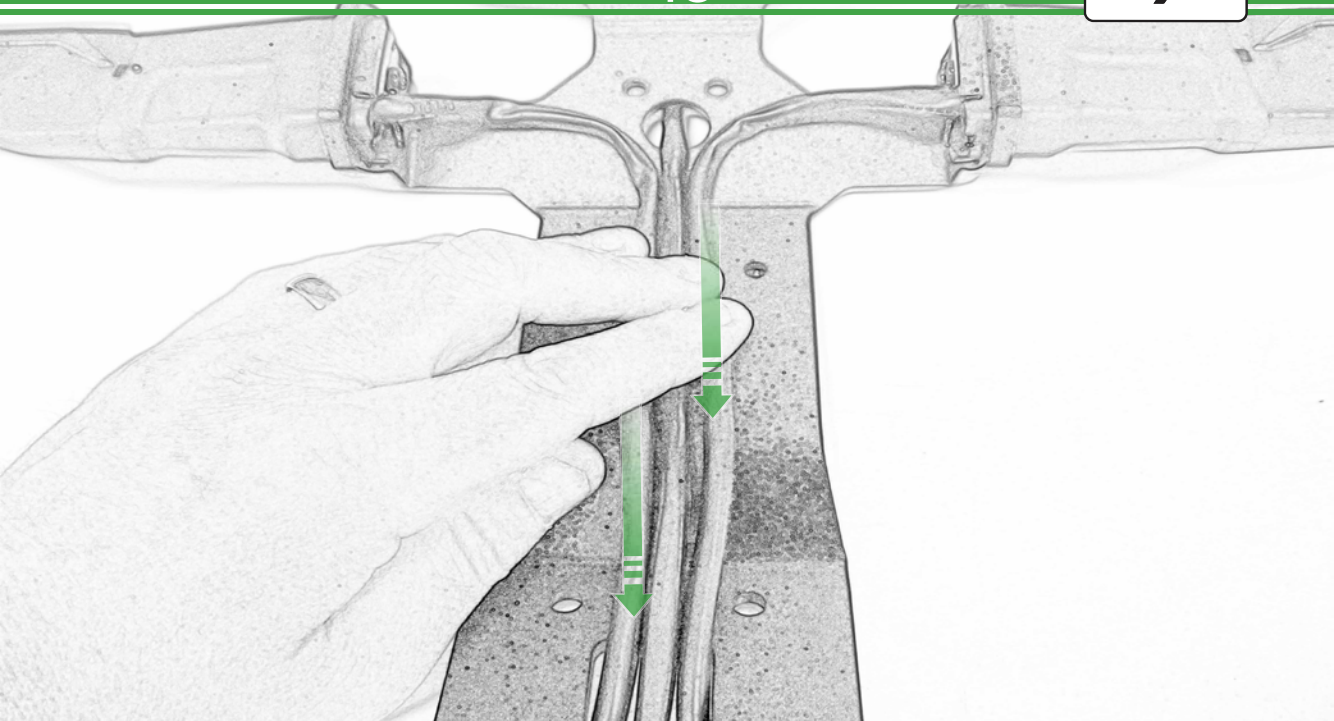

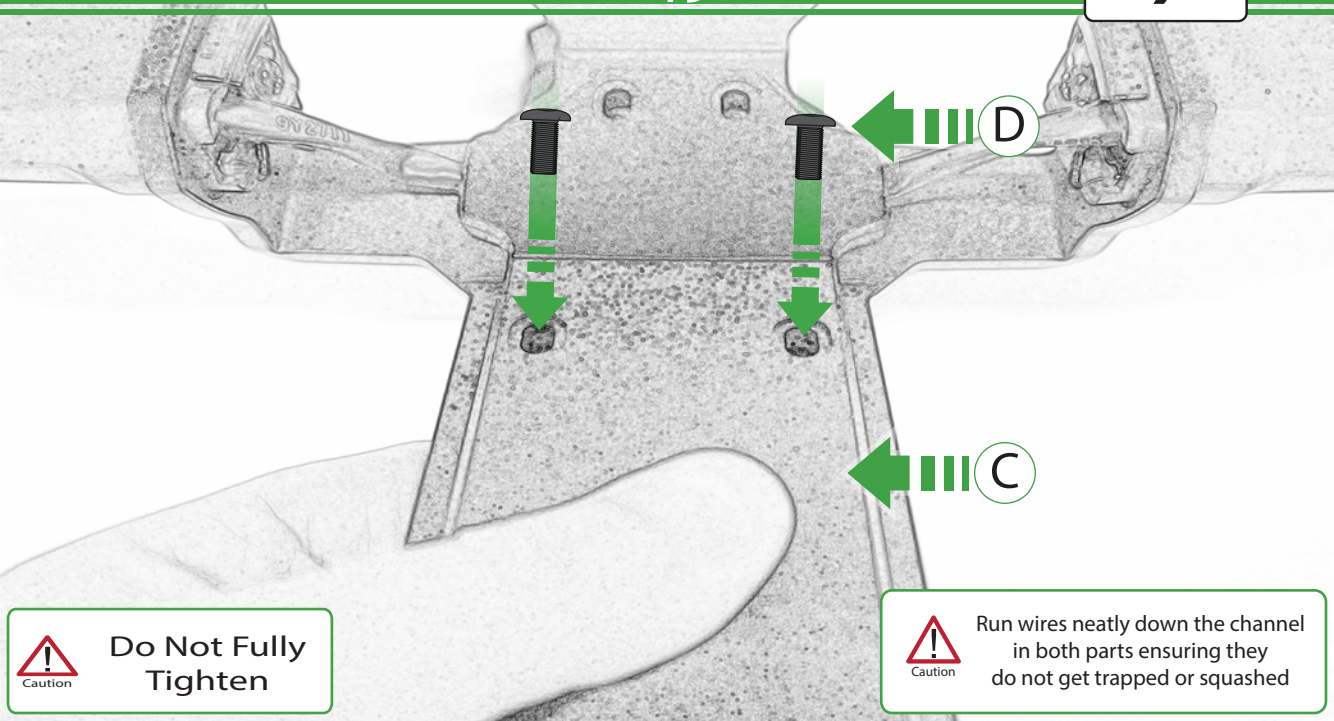

D

C



Do Not Fully Tighten



Run wires neatly down the channel in both parts ensuring they do not get trapped or squashed

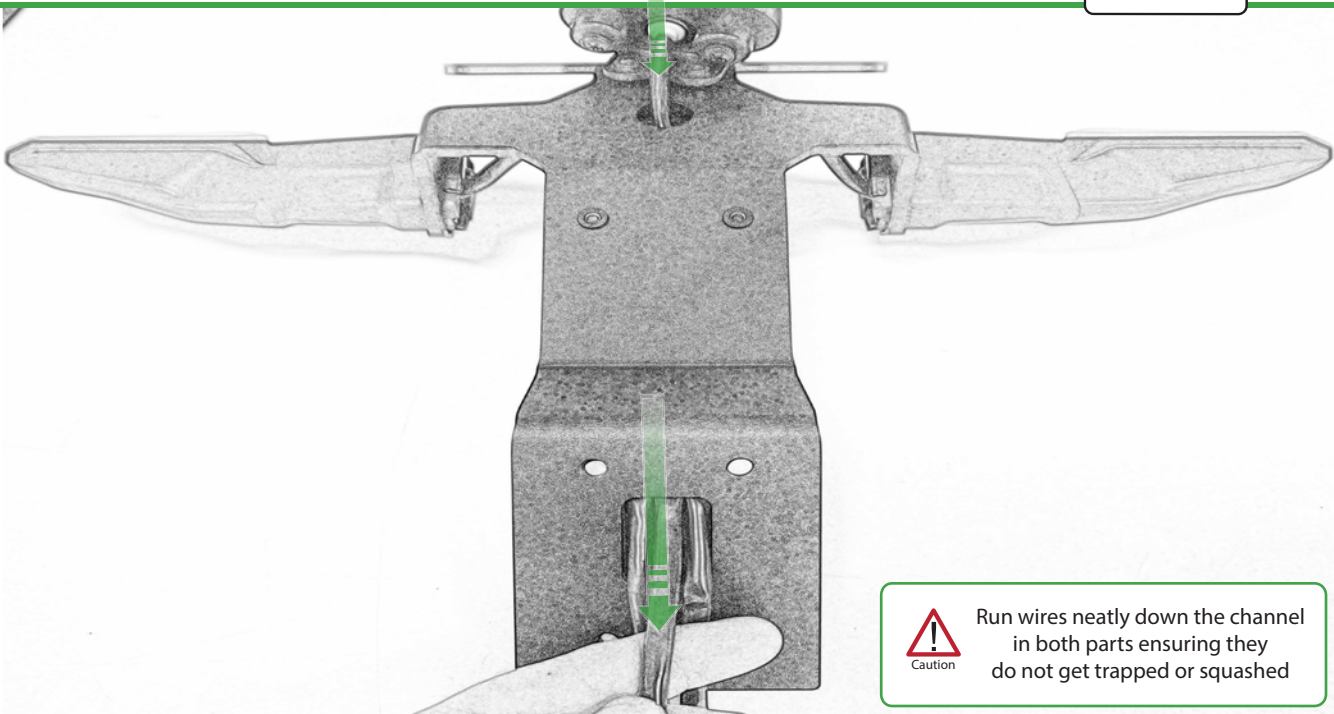

Caution

Run wires neatly down the channel in both parts ensuring they do not get trapped or squashed

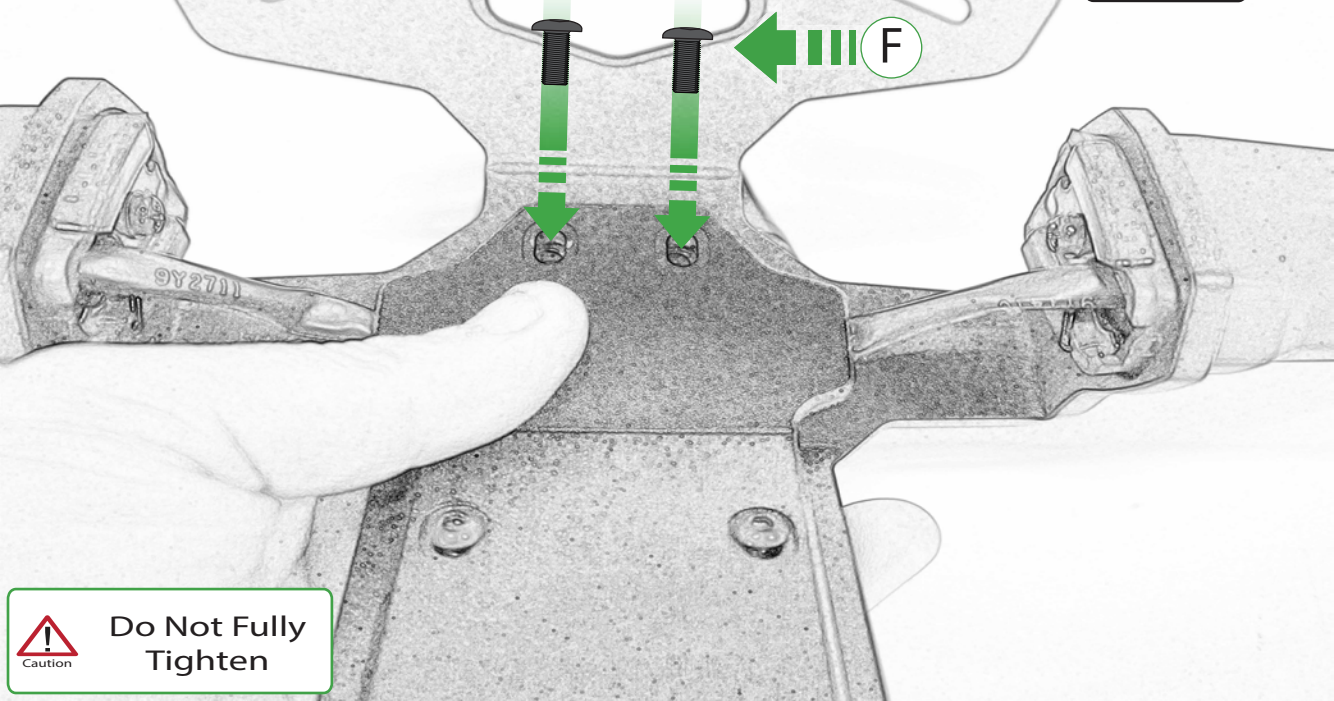

Do Not Fully Tighten

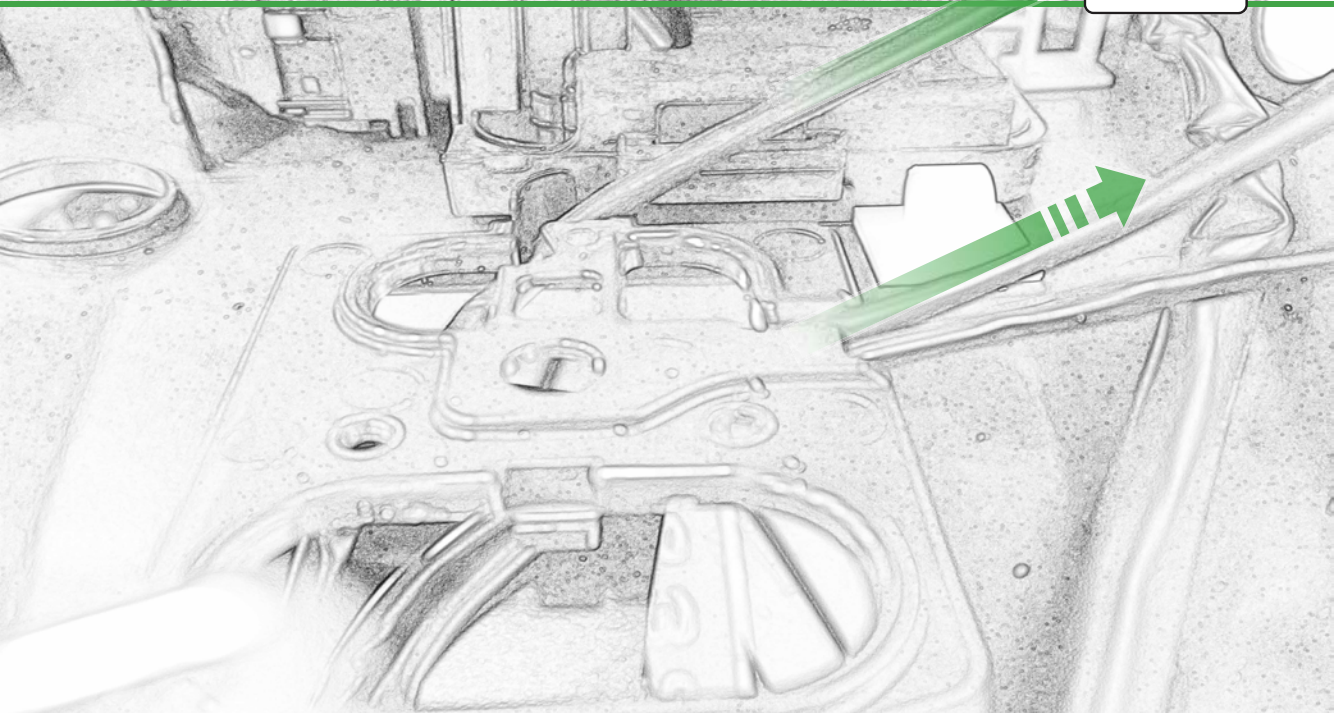

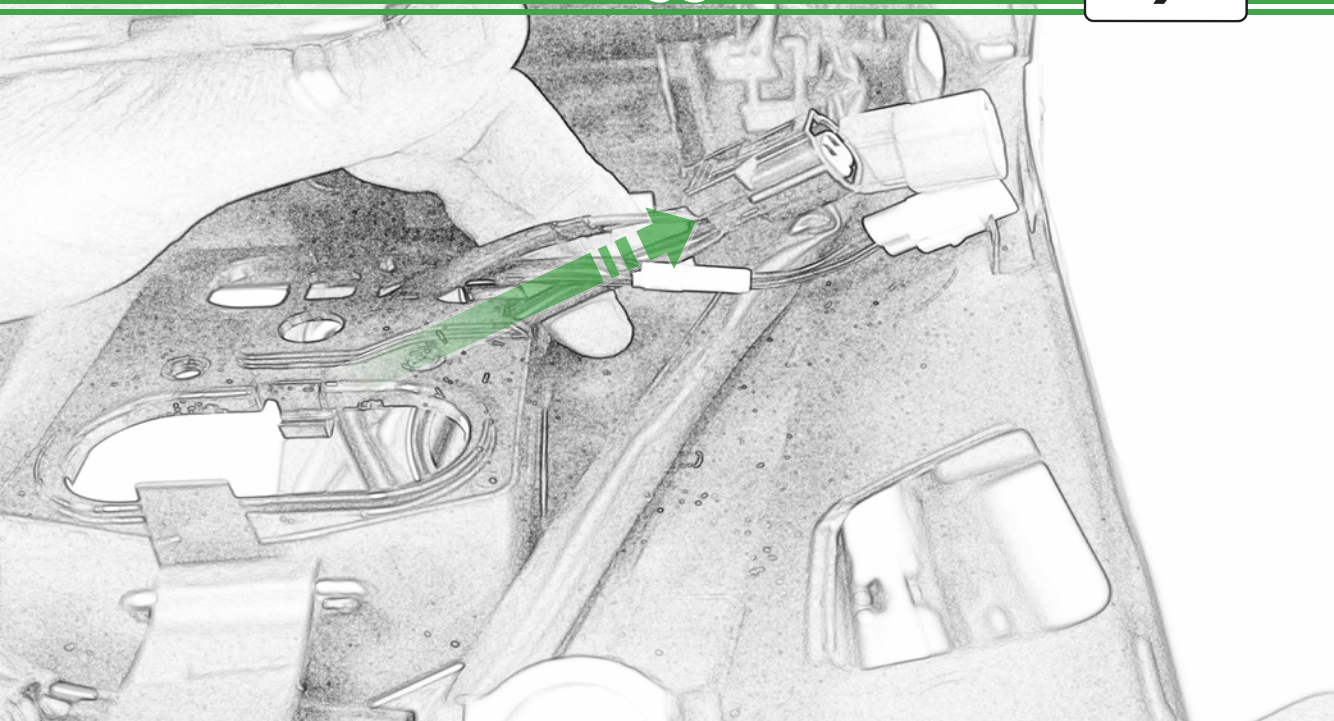

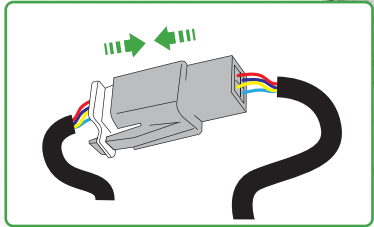

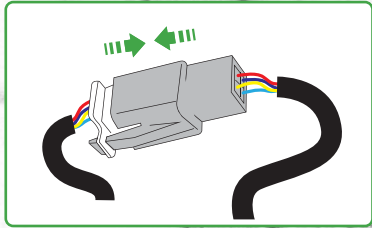
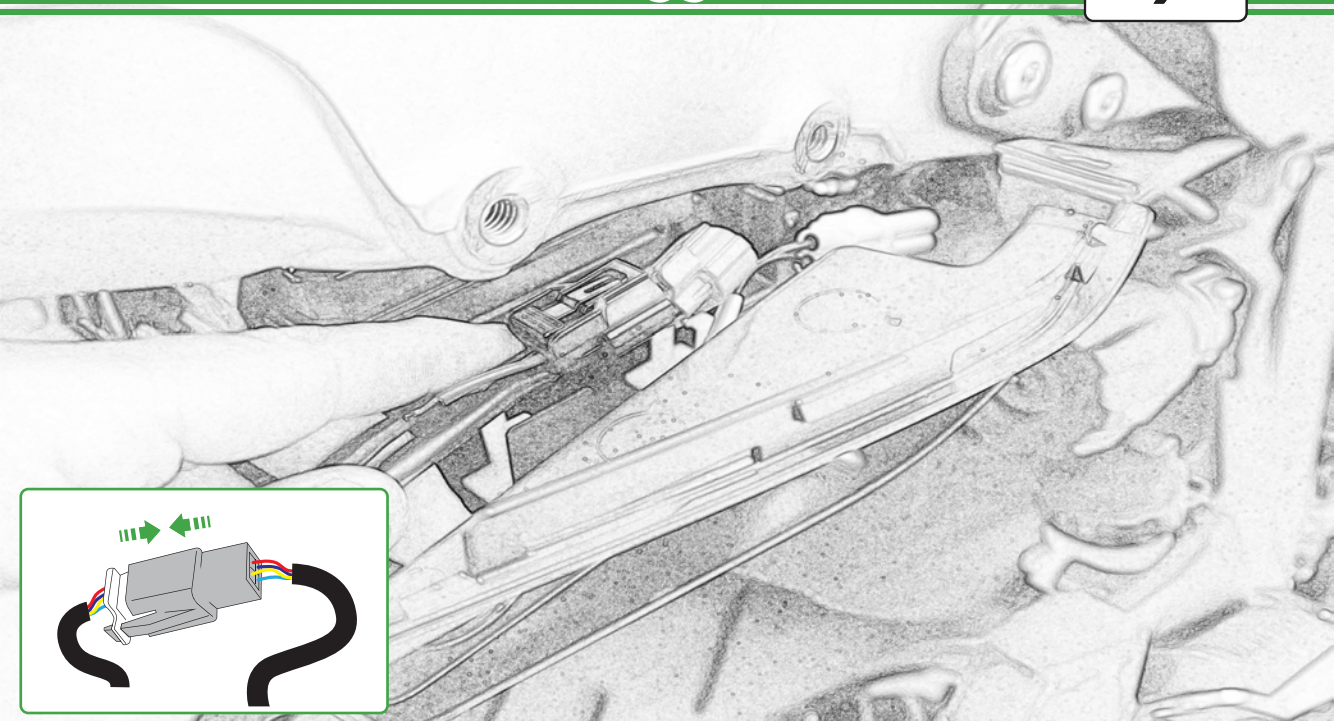

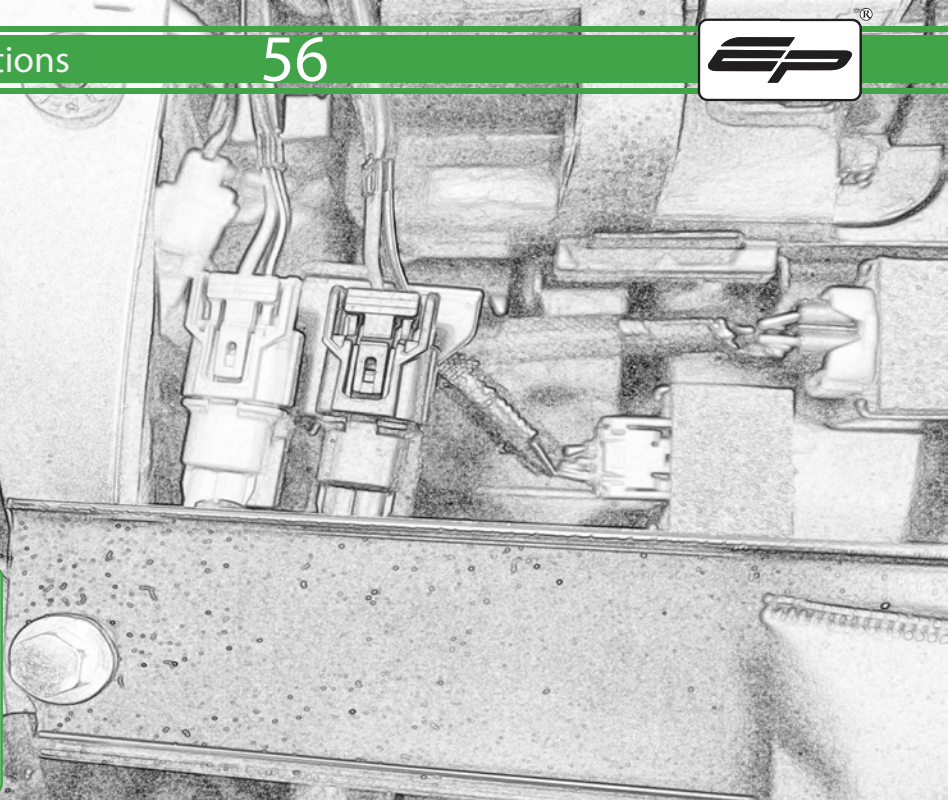
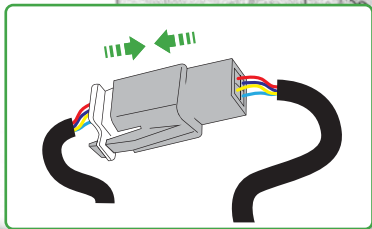





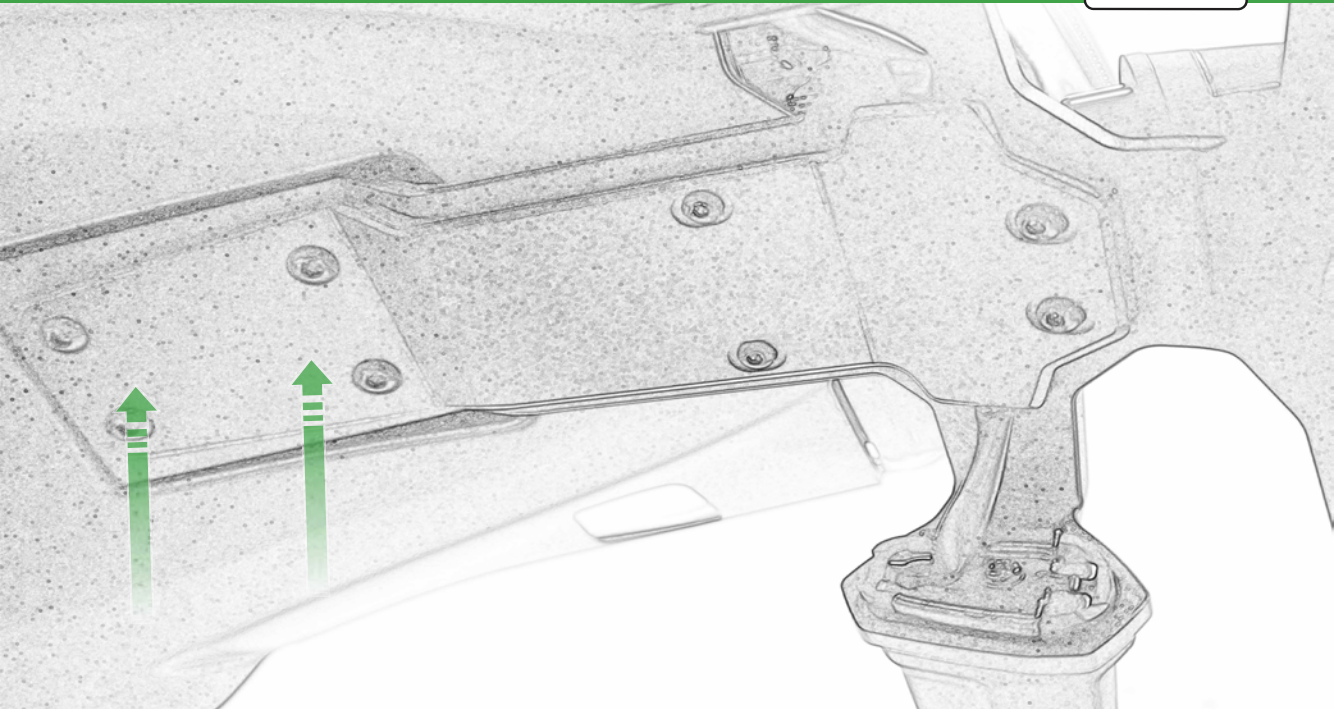

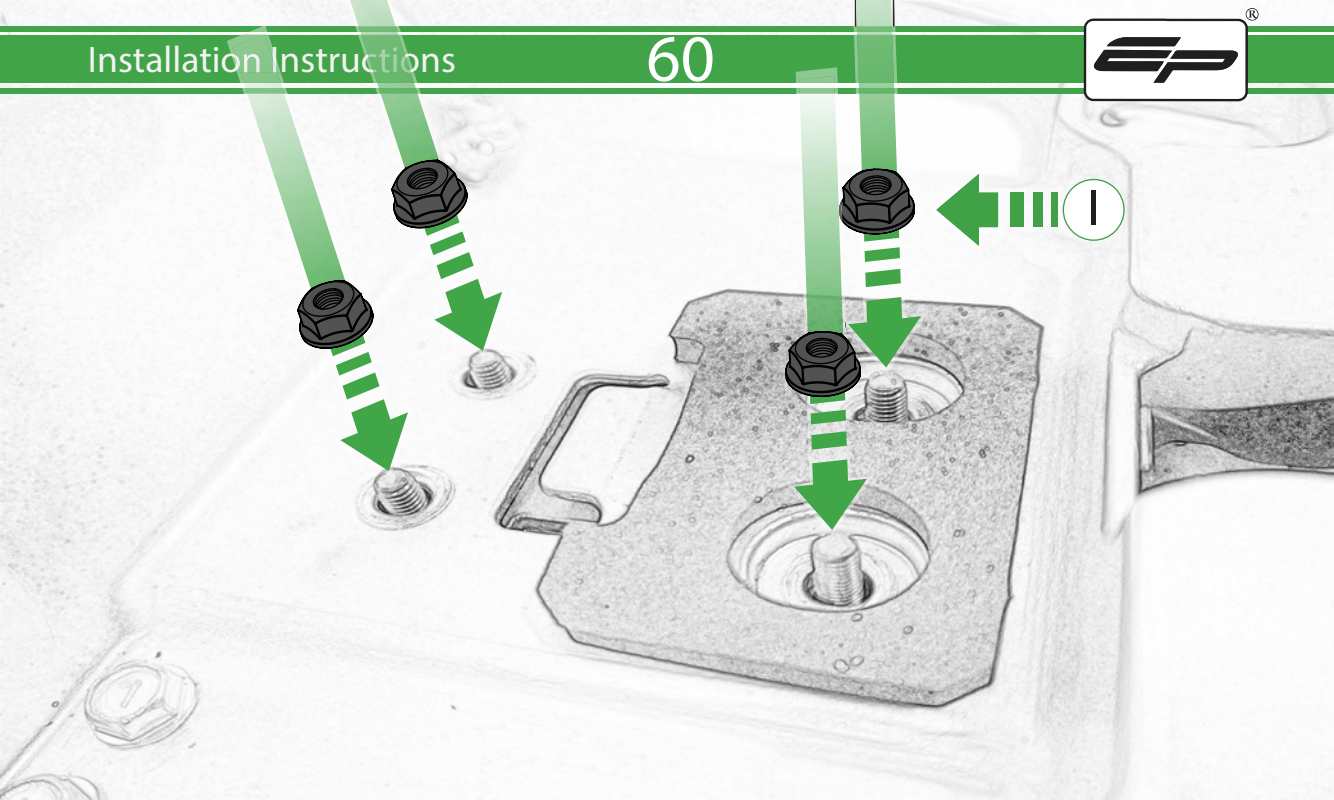

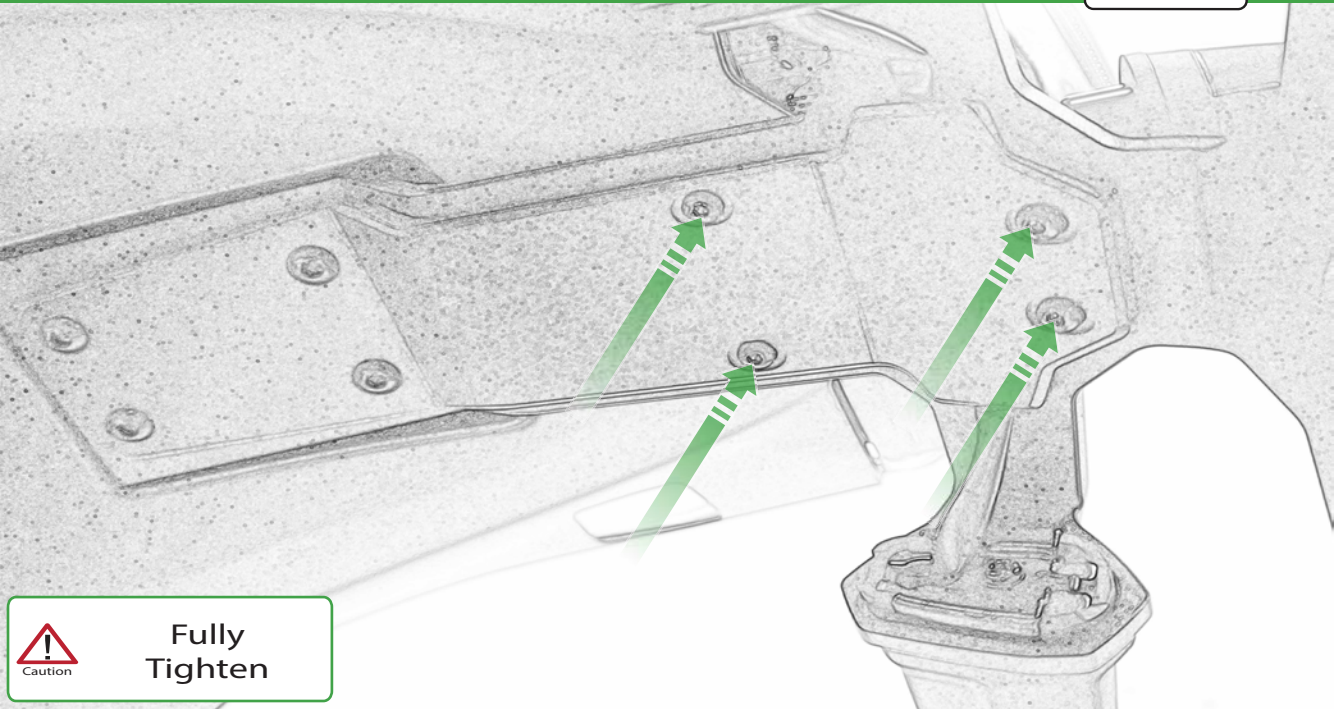

Caution

Fully
Tighten

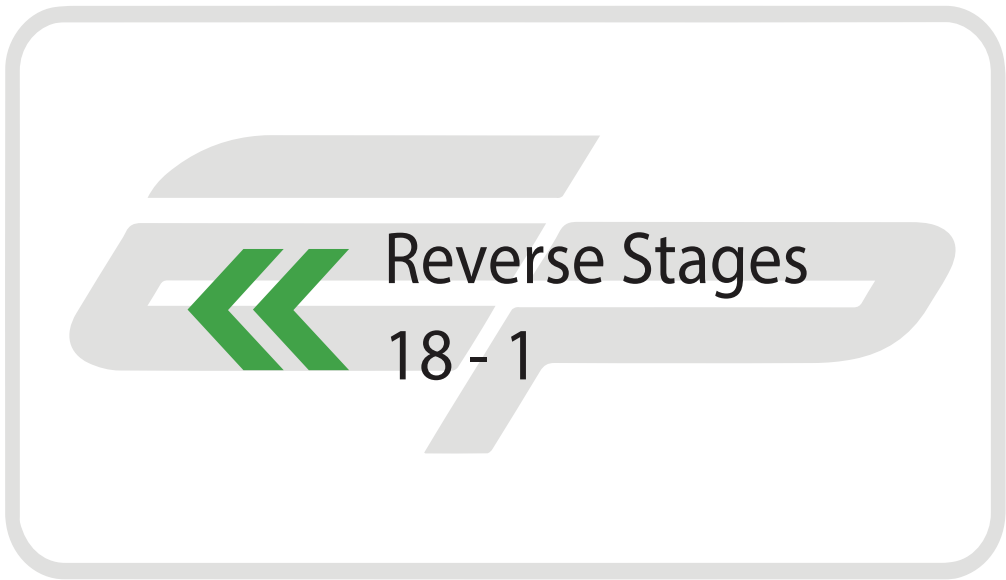

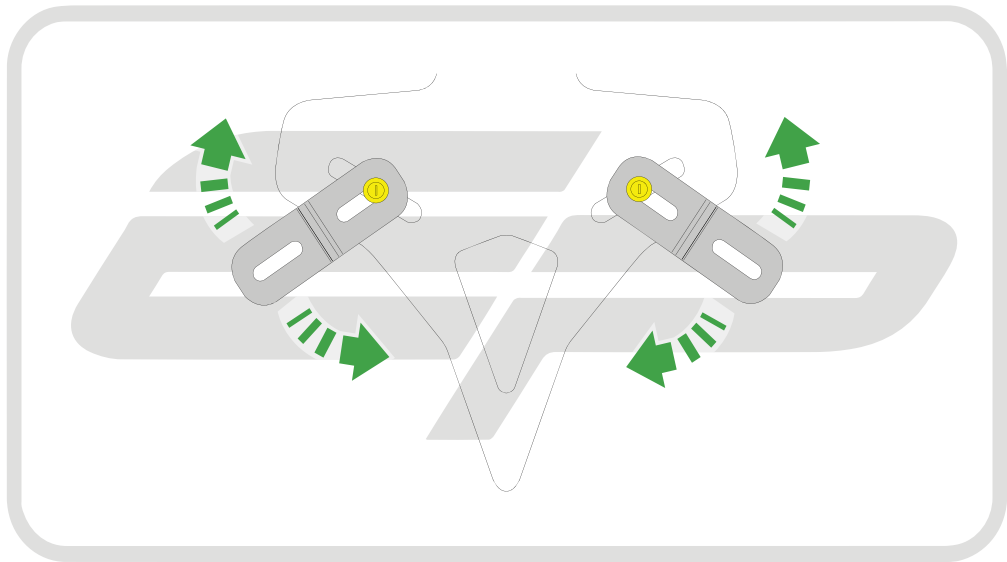

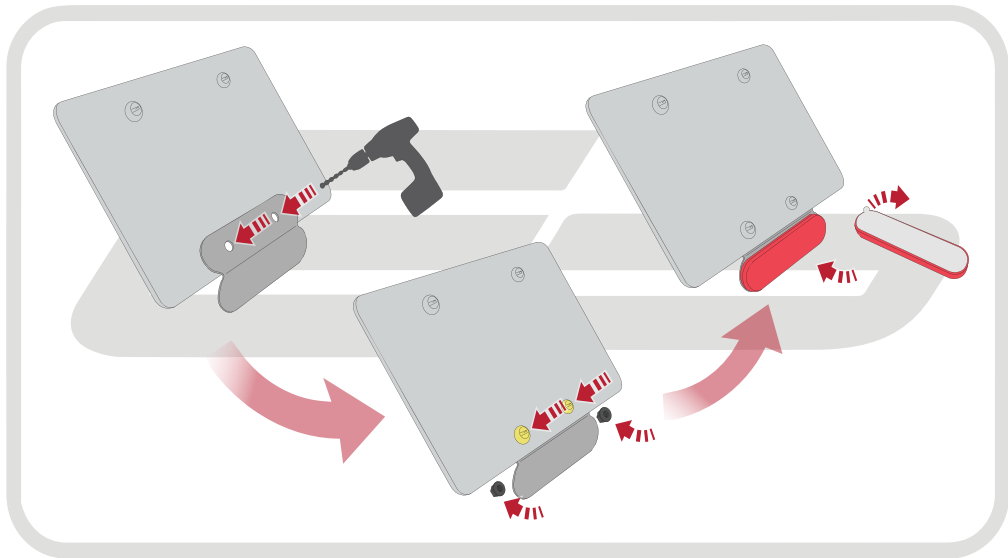



ESSENTIAL CHECKS



After installation of your tail tidy ensure that the licence plate does not contact the rear tyre when suspension is fully compressed.

Ensure all electrics including indicators, tail light, brake light and licence plate light lights are working correctly before riding the motorcycle.

It is recommended that periodic inspections are made to ensure that all fixings are fully tightend.



EVOTECH®
P E R F O R M A N C E

www.evotech-performance.com