

EVOTECH®
P E R F O R M A N C E

www.evotech-performance.com

Triumph Tiger 1200
QuadLock Sat Nav Mount



Kit Contents

- Ⓐ 1 x Main Plate
- Ⓑ 1 x Pivot Plate
- Ⓒ 1 x Quad Lock Sub Bracket
- Ⓓ 1 x Quad Lock Mounting Bracket
- Ⓔ 2 x M5 x 8mm Black Button Head Bolts
- Ⓕ 2 x P-clips (No.1)
- Ⓖ 2 x P-clips (No.2)
- Ⓗ 2 x P-clips (No.3)
- Ⓘ 2 x P-clips (No.4)
- Ⓙ 2 x Lobe Screw
- Ⓚ 2 x Locking Washer
- Ⓛ 2 x M5 Black Washer
- Ⓜ 2 x M4 x 5mm Black Button Head Bolts
- ⒶⒶ 2 x M5 x 25 Silver Button Head Bolt
- ⒷⒷ 2 x M5 x 20 Silver Button Head Bolt
- ⒸⒸ 4 x Top Hat Spacer

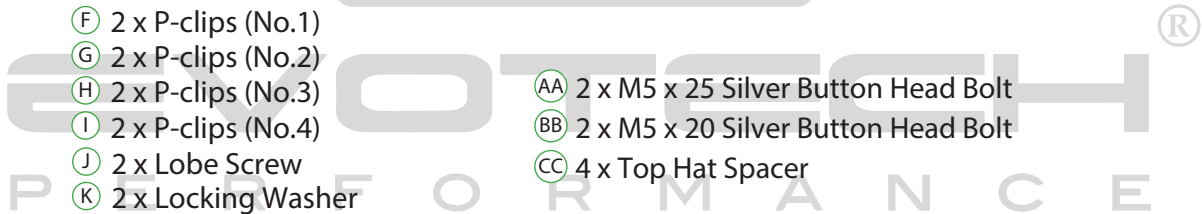
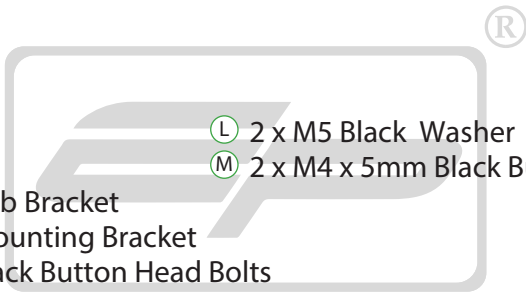

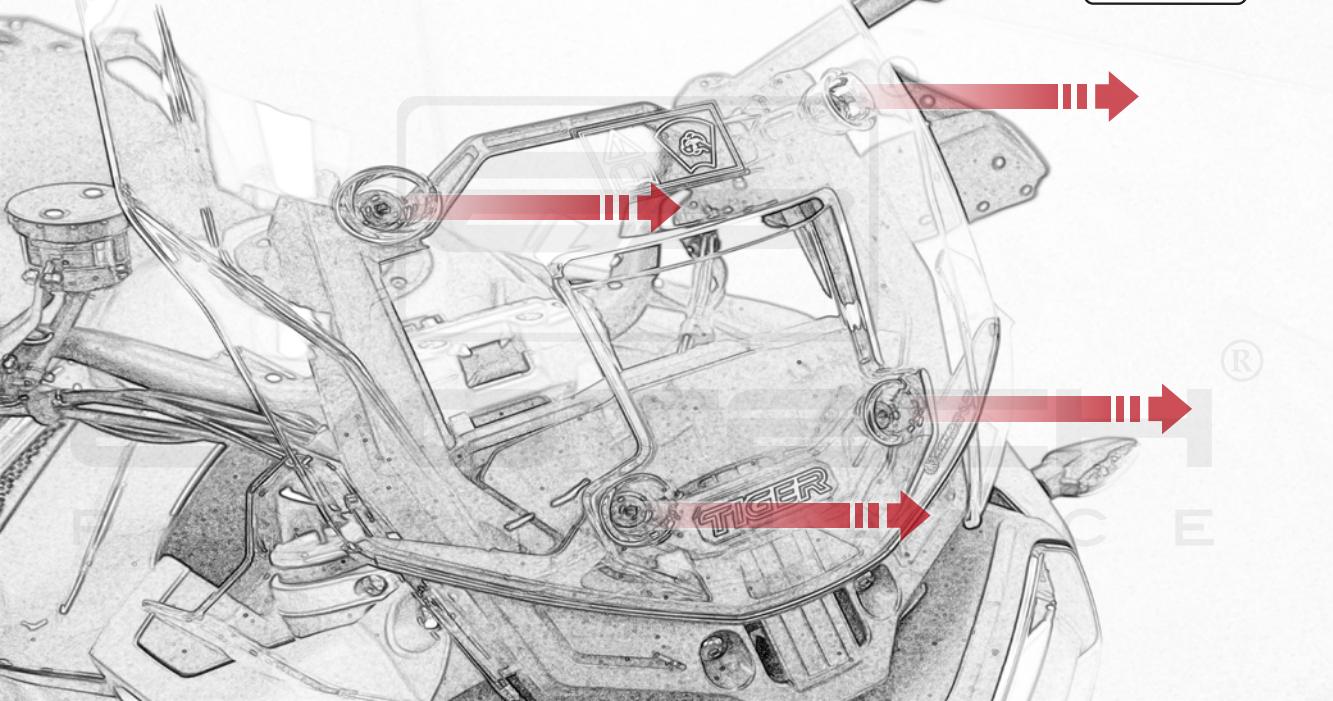

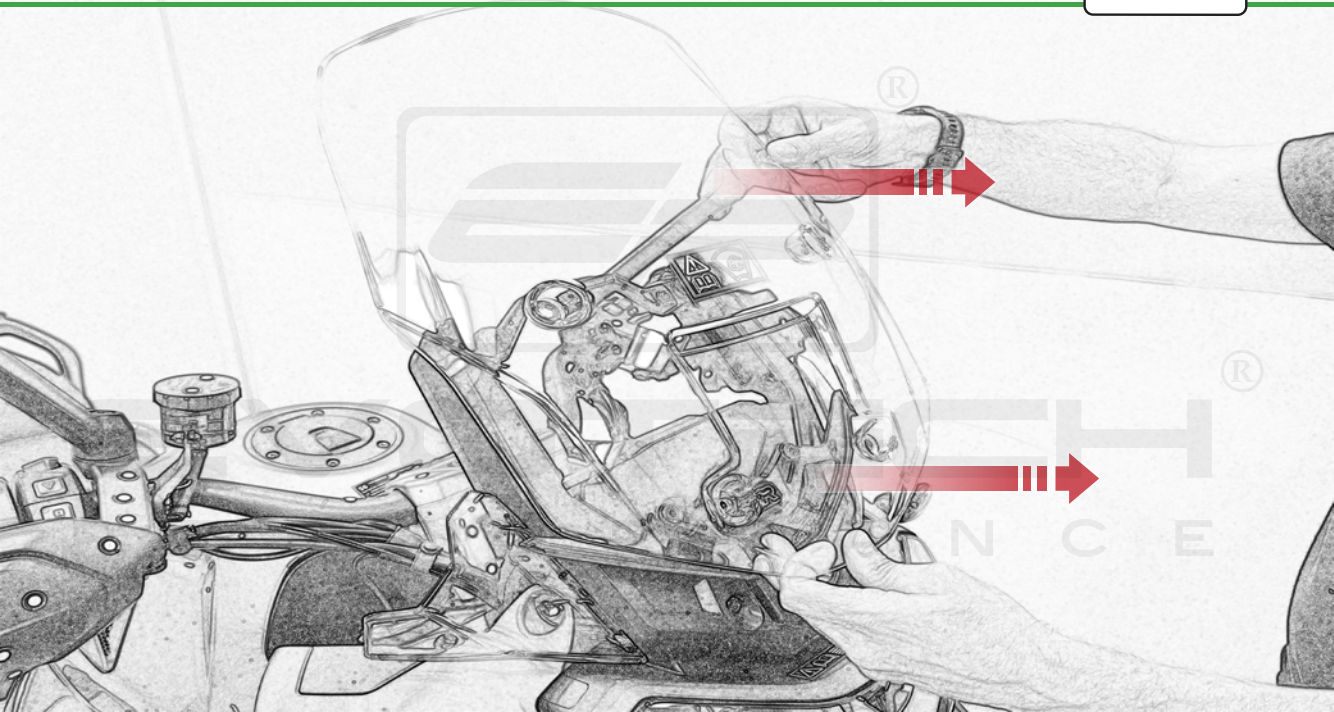



EvoRech[®]
PERFORMANCE

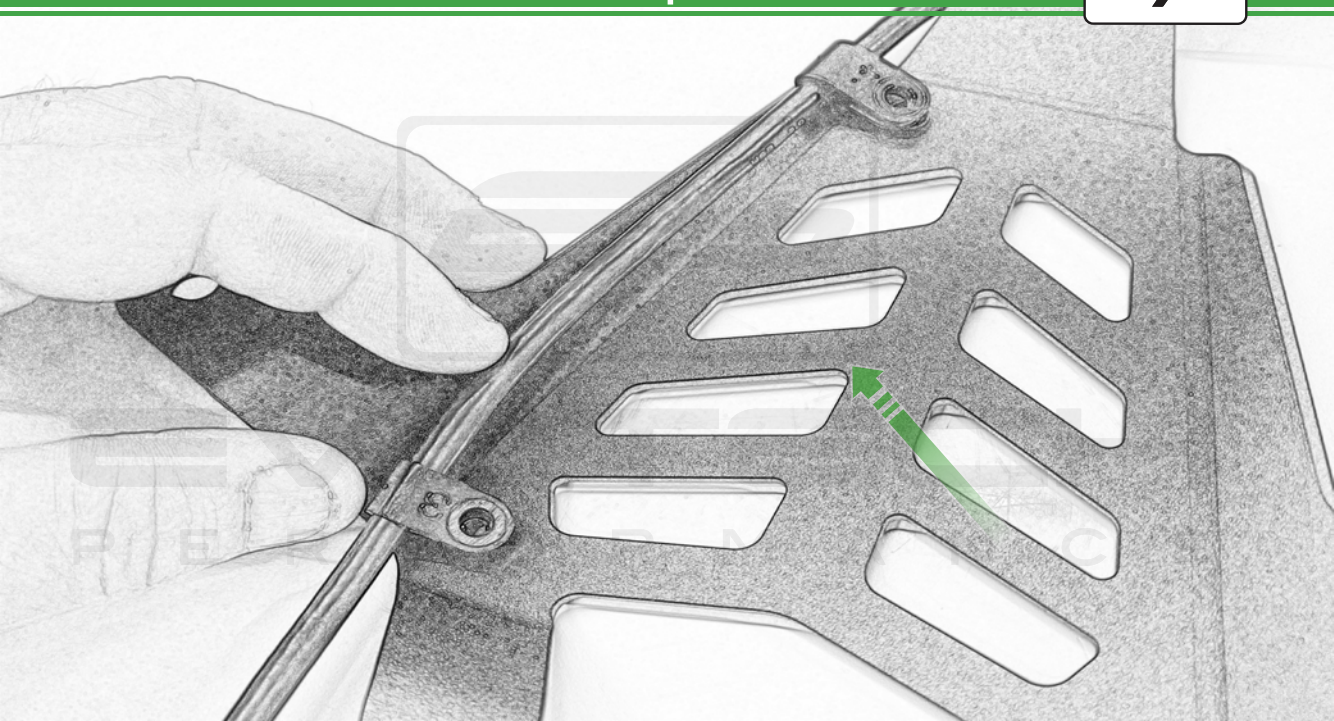

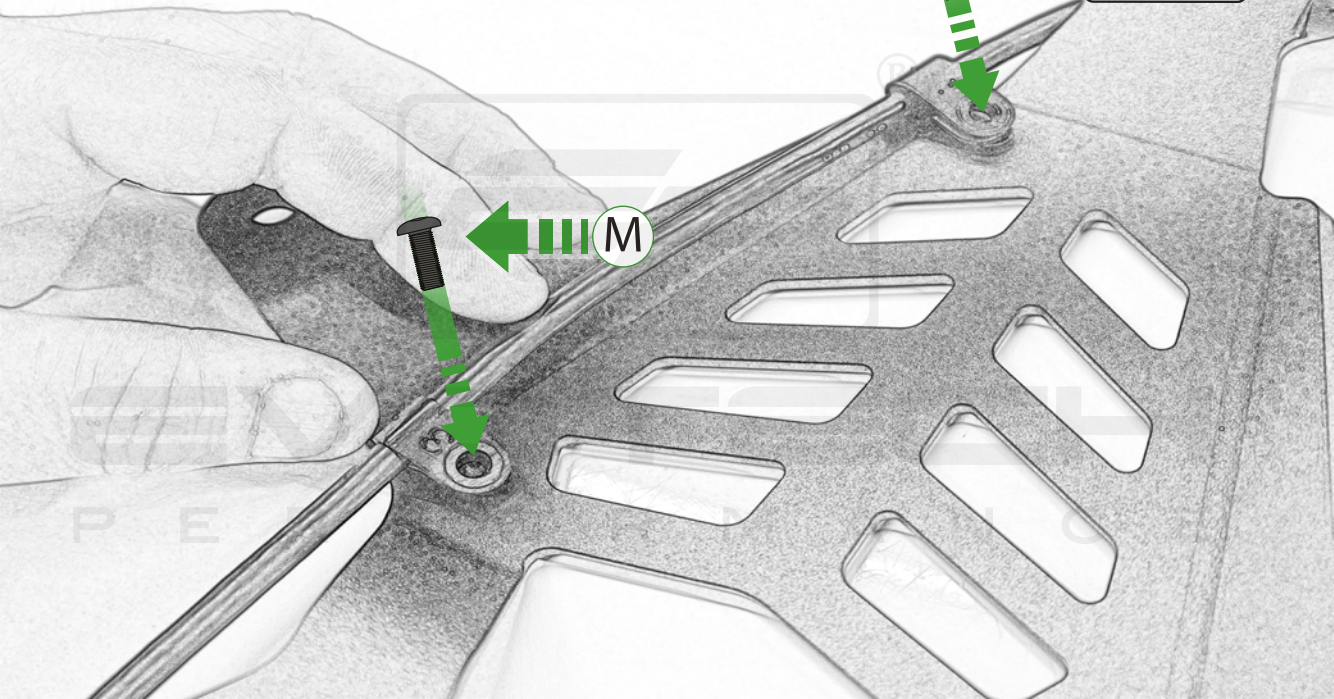

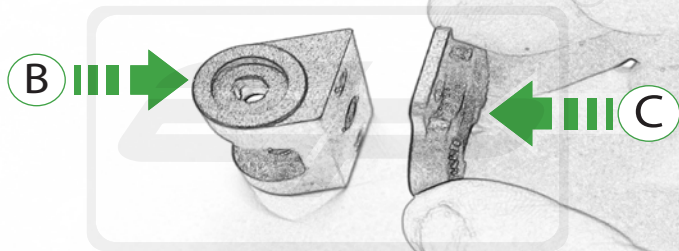

EVOTECH
P E R F O R M A N C E

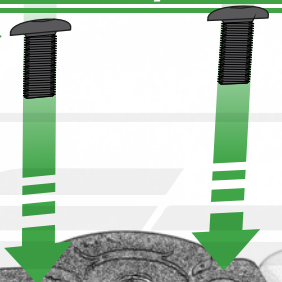

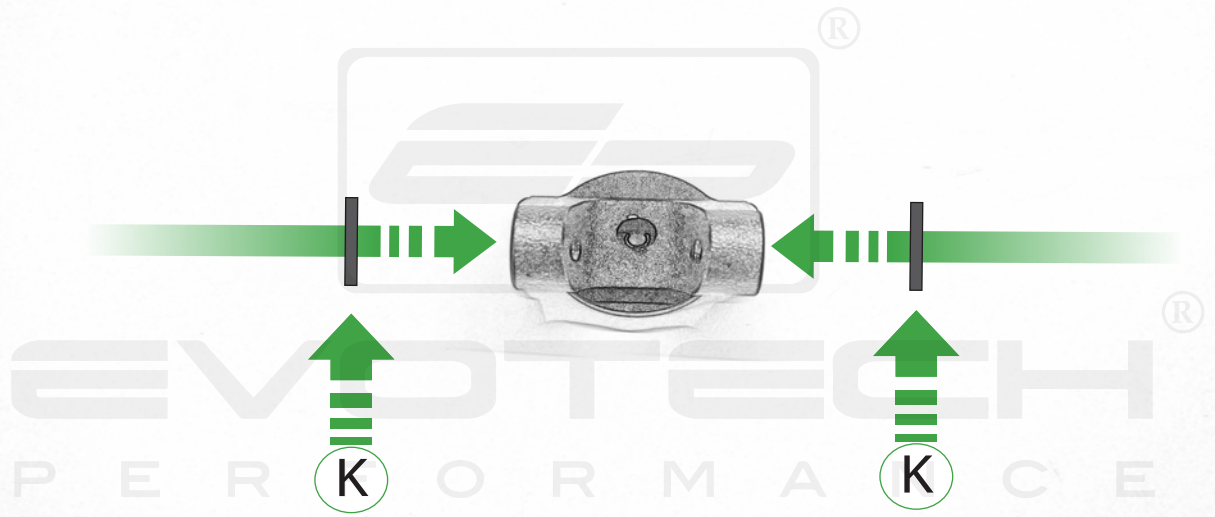



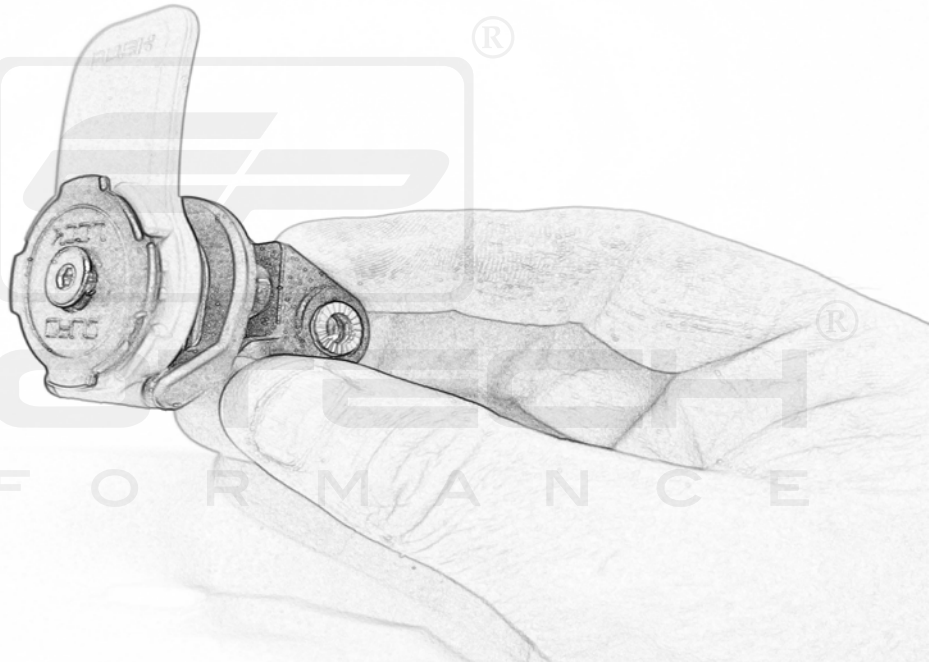

EVO
PERFORMANCE

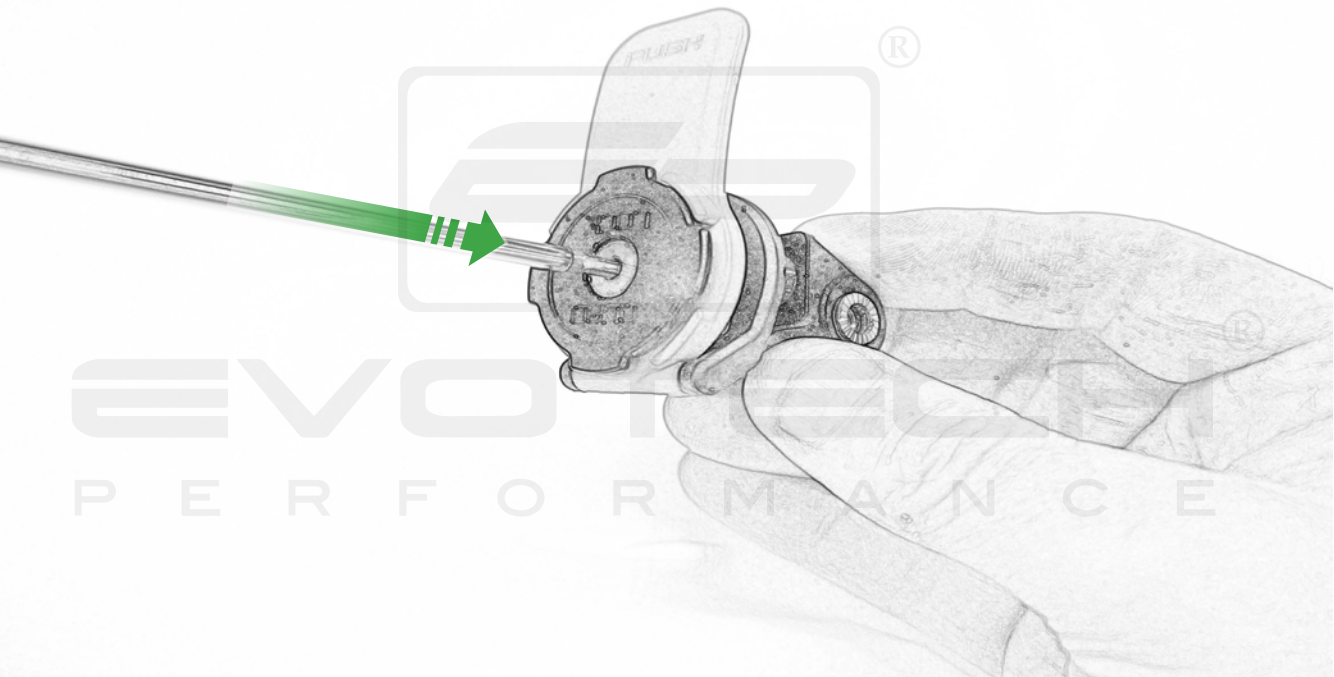

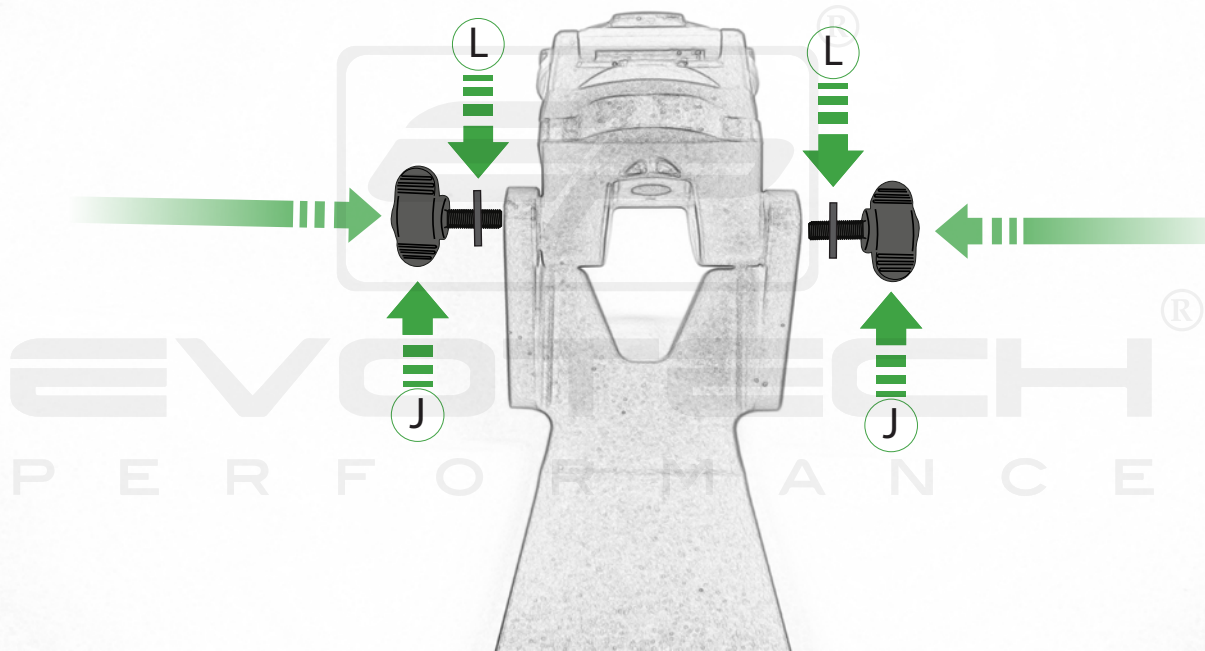

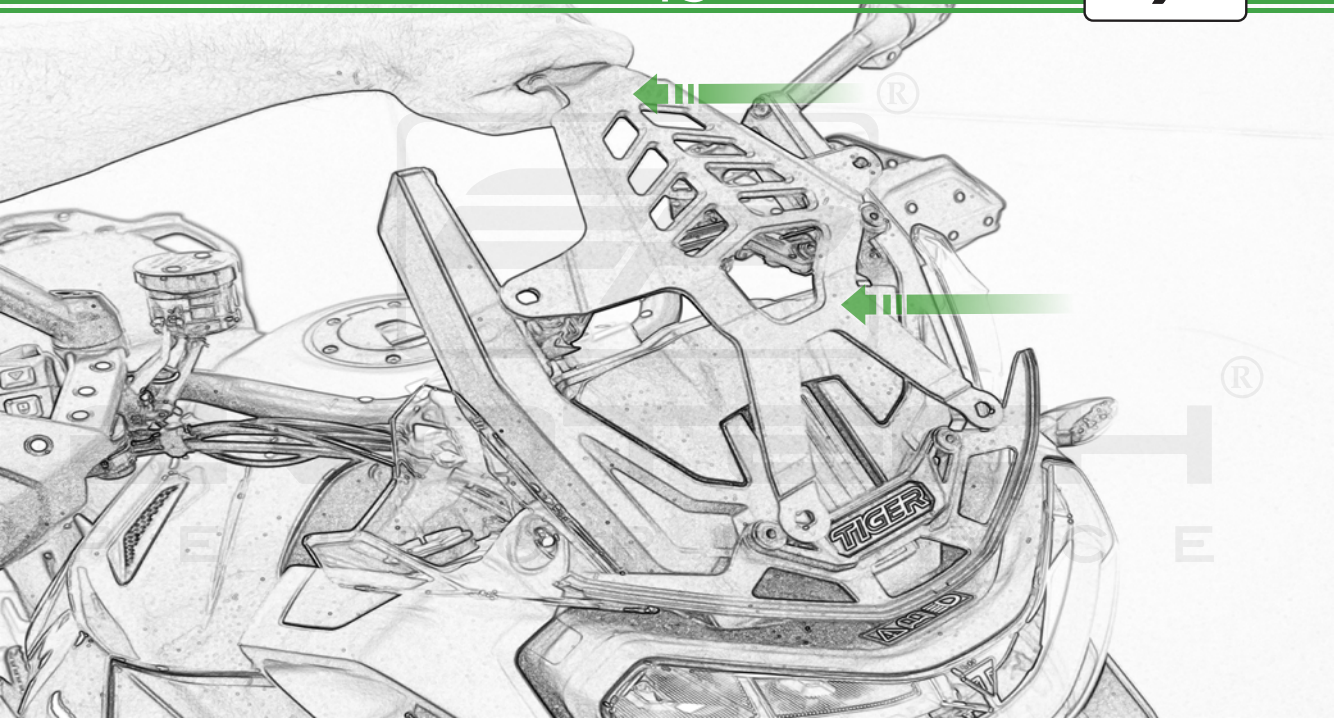

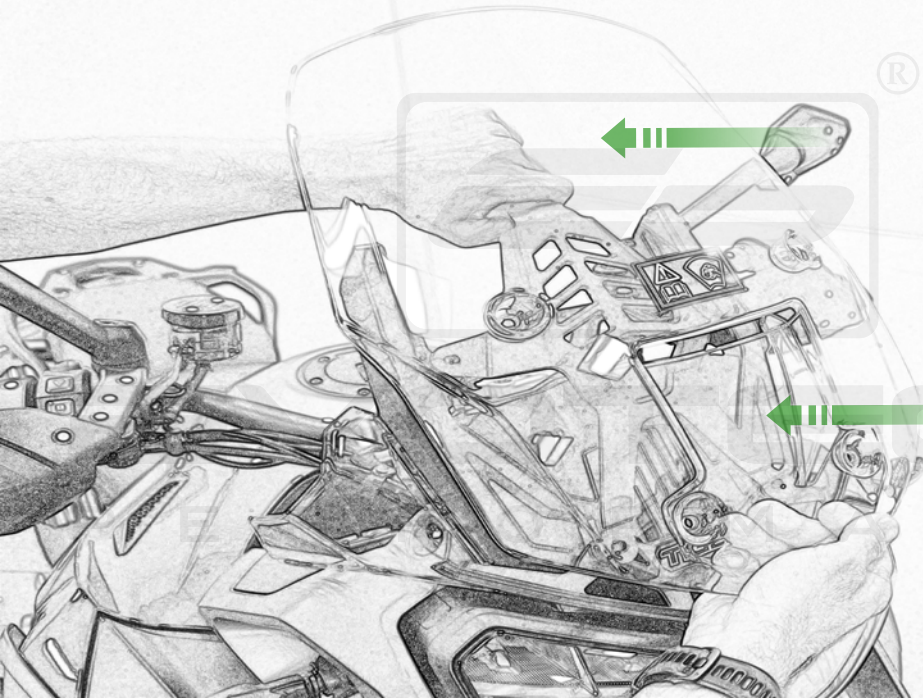

®

®

TECH
NCE



Ensure Seal
Isn't Trapped

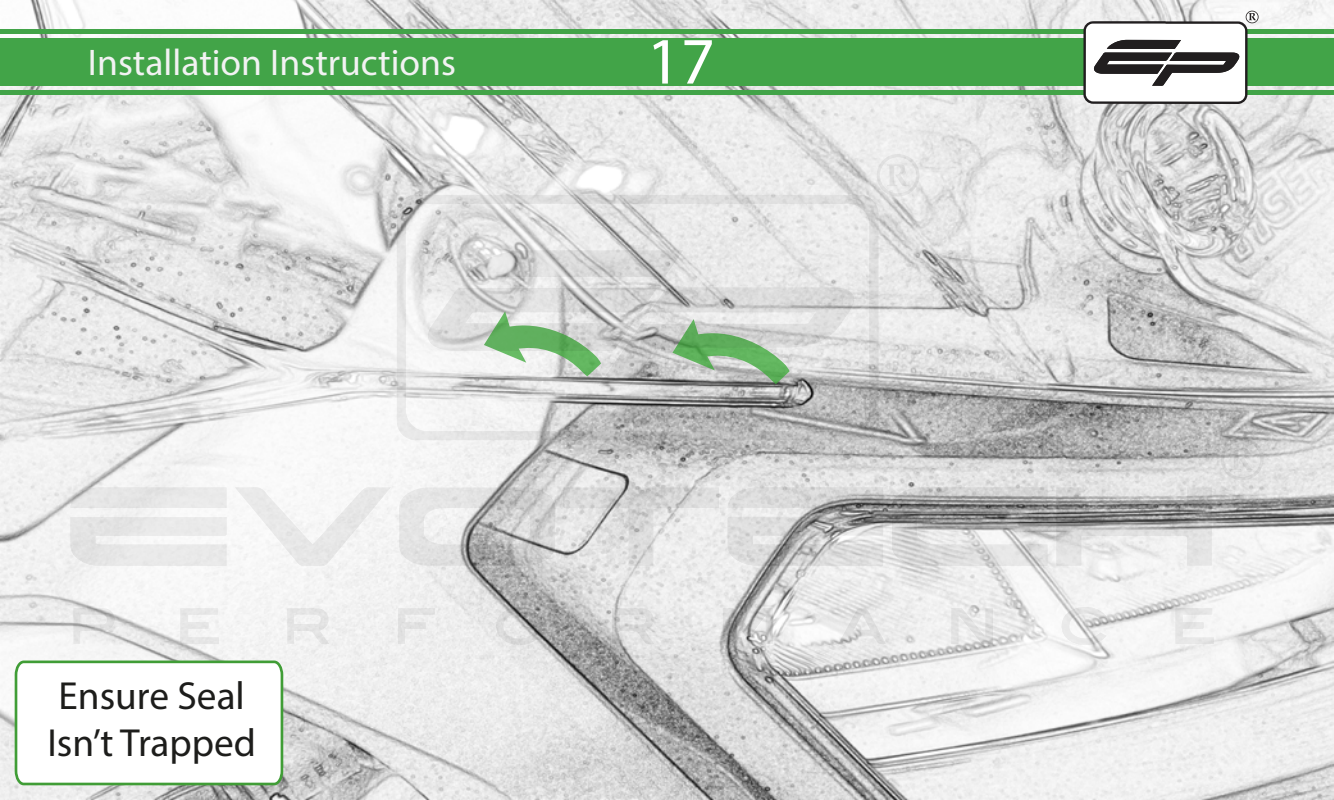

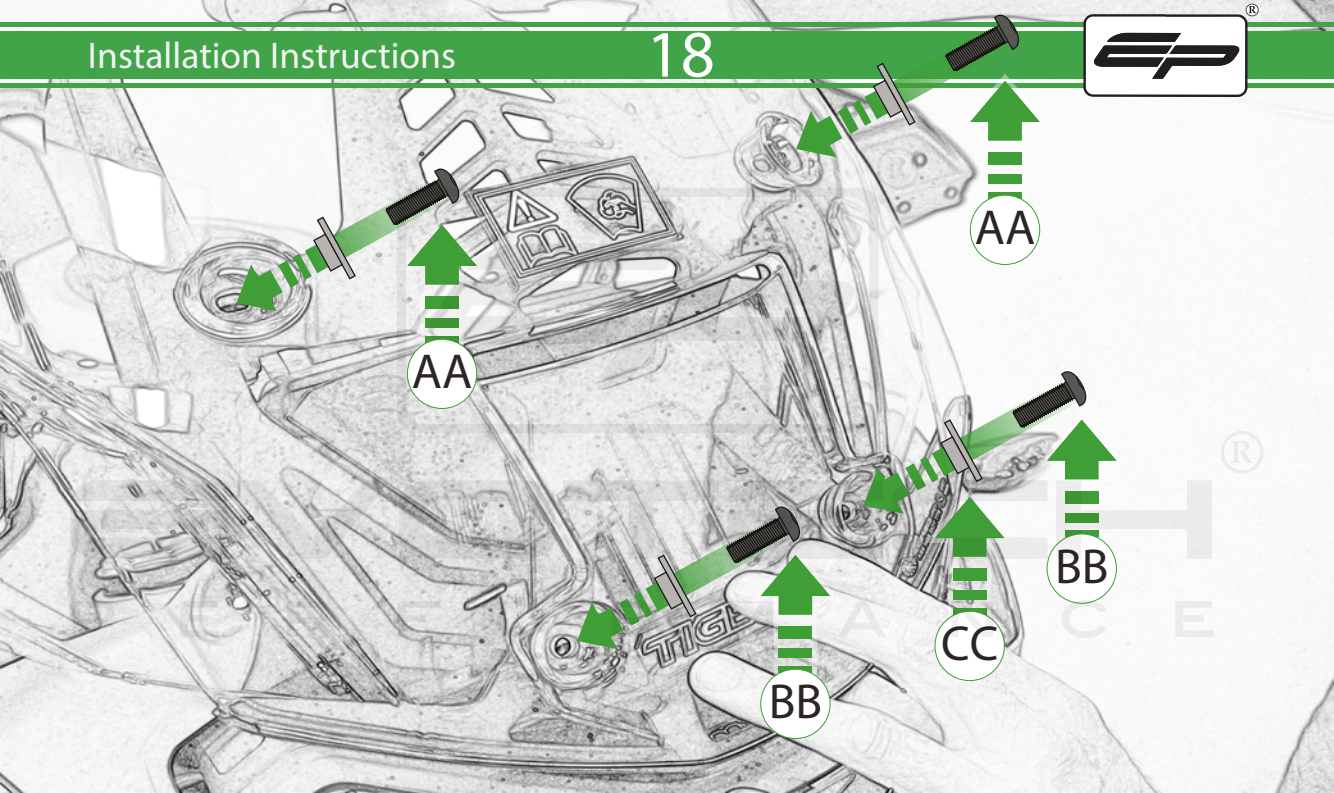

AA

AA

BB

BB

CC

TIGER



ESSENTIAL CHECKS



It is recommended that periodic inspections are made to ensure that all bolts are tightened to the specified torque settings.

Should the bike be involved in an accident a thorough inspection should be made and any components that have taken an impact, no matter how small, be replaced



EVOTECH®
P E R F O R M A N C E

www.evotech-performance.com