



EVOTECH®
P E R F O R M A N C E

www.evotech-performance.com

Aprilia RS660

Quad Lock Mount



- Ⓐ 1 x Main Plate
- Ⓑ 1 x Pivot Plate
- Ⓒ 1 x Quad Lock Sub Bracket
- Ⓓ 1 x Quad Lock Mounting Bracket
- Ⓔ 2 x M5 x 8mm Black Button Head Bolts
- Ⓕ 2 x P-clips (No.1)
- Ⓖ 2 x P-clips (No.2)
- Ⓗ 2 x P-clips (No.3)
- Ⓘ 2 x P-clips (No.4)
- Ⓙ 2 x Lobe Screw
- Ⓚ 2 x Locking Washer
- Ⓛ 2 x M5 Black Washer
- Ⓜ 2 x M4 x 5mm Black Button Head Bolts
- ⒶⒶ 2 x Spacer
- ⒷⒷ 2 x M8 x 55mm Caphead

EP [®]
PERFORMANCE

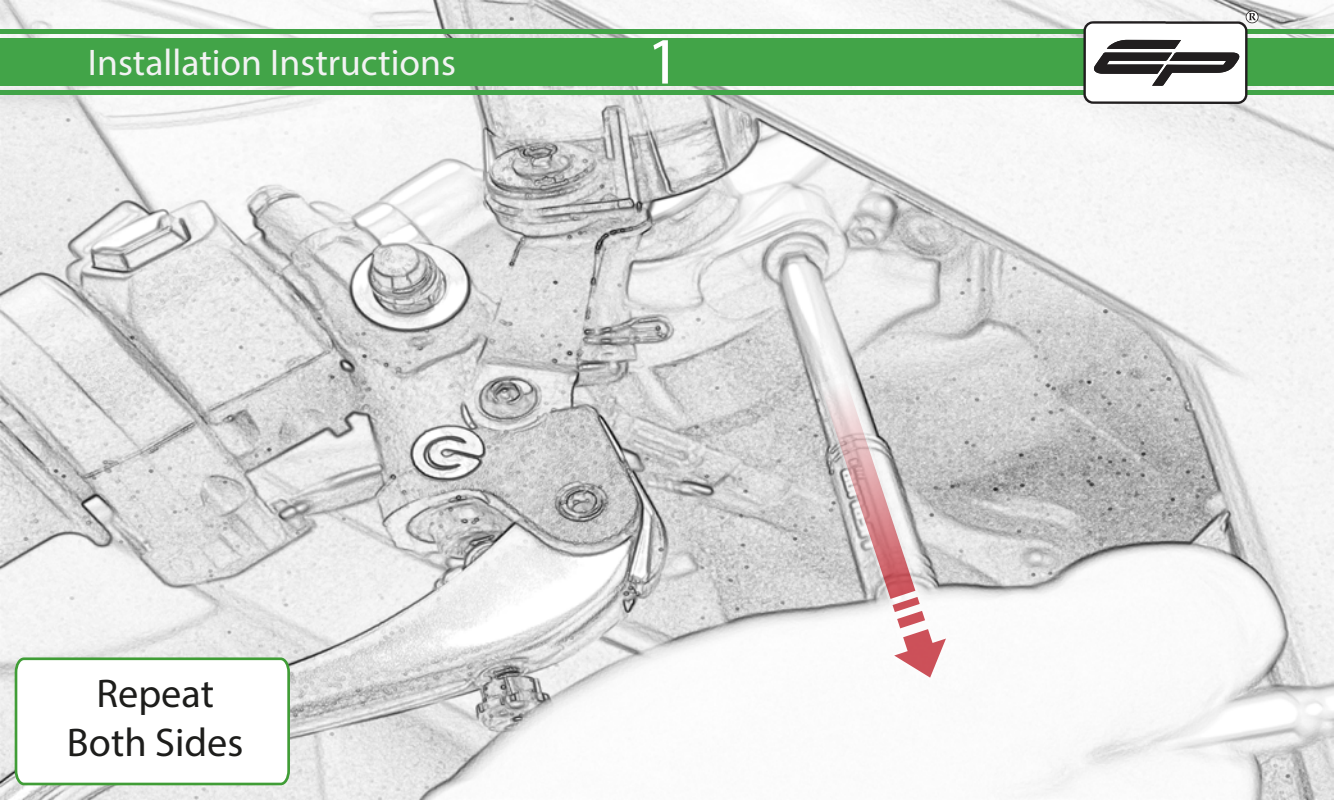

Repeat
Both Sides



Repeat
Both Sides

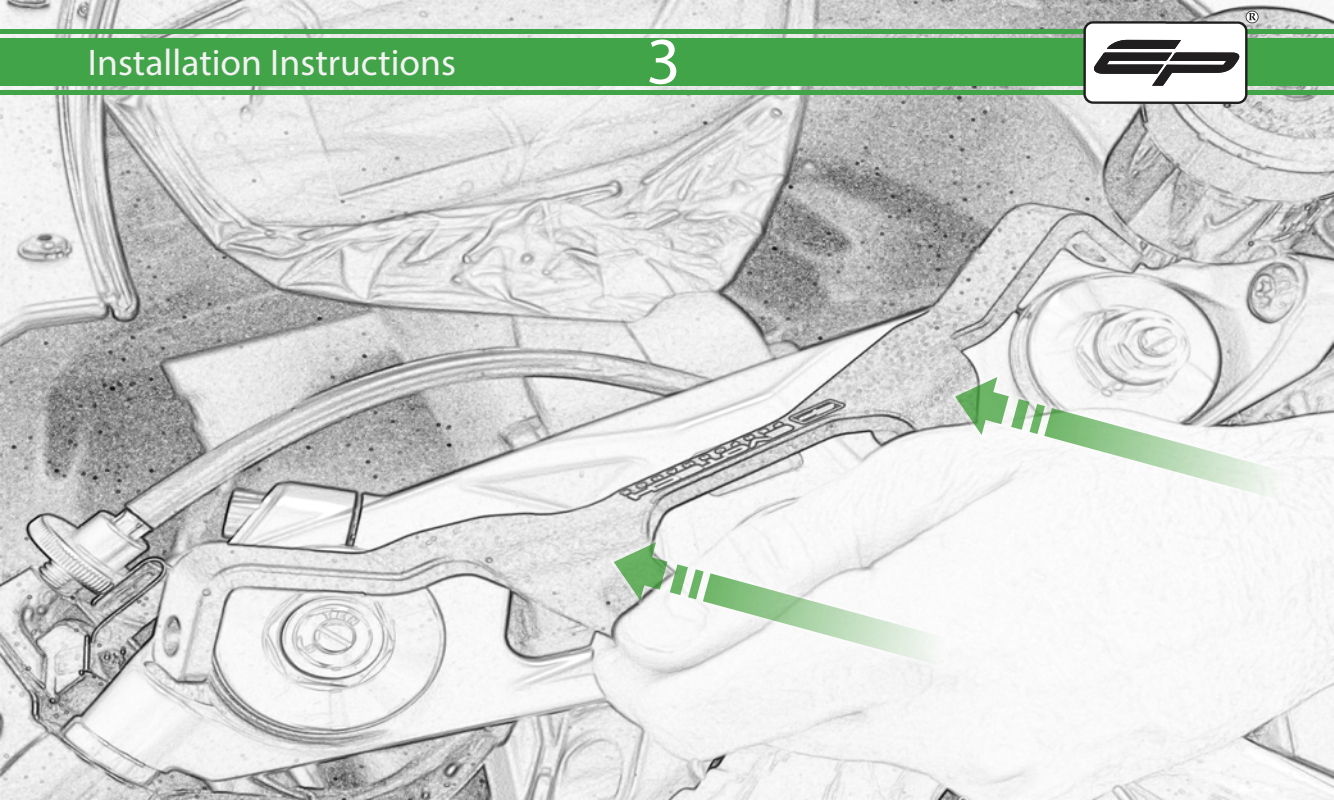

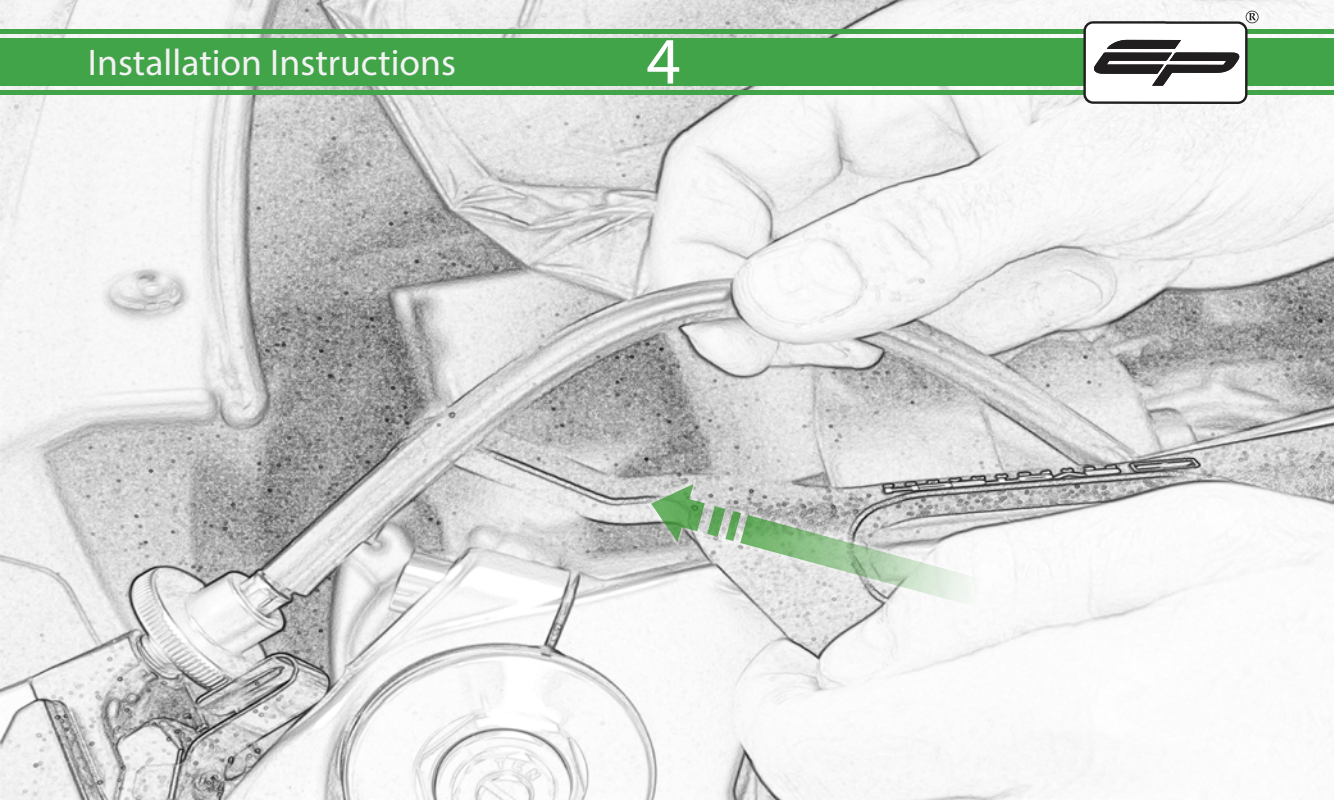

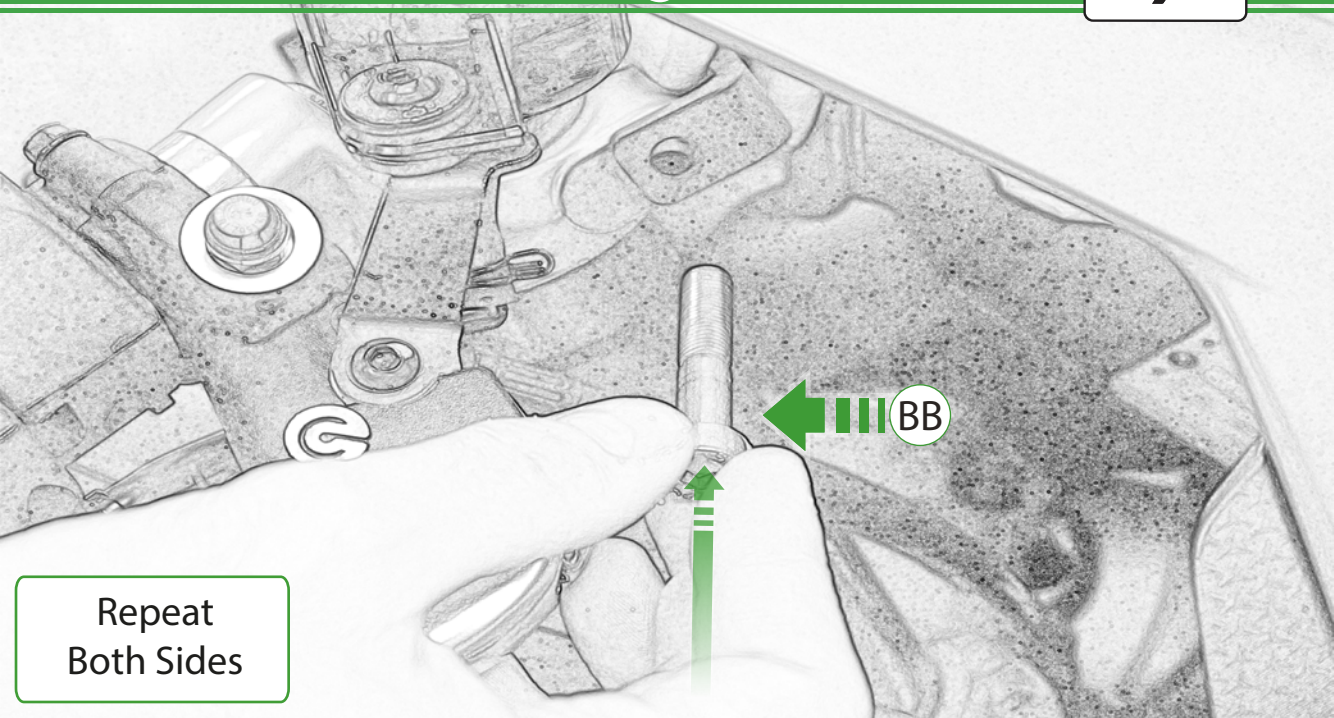

Repeat
Both Sides

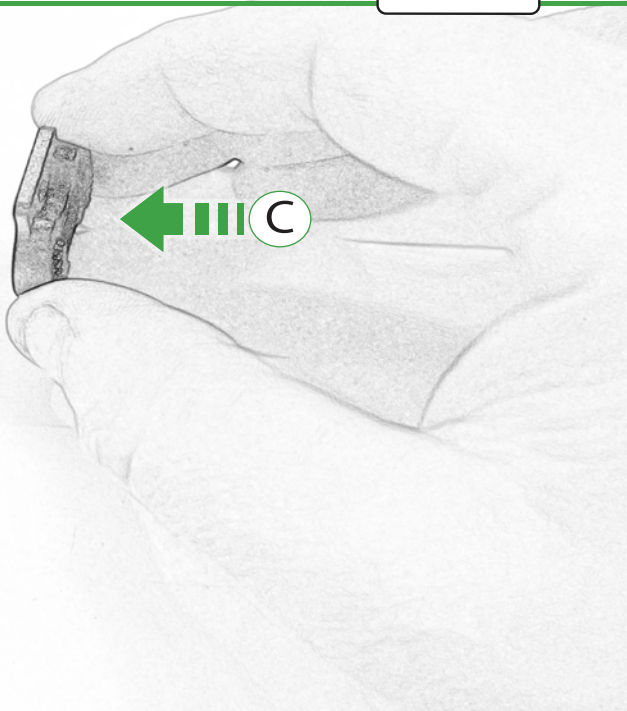



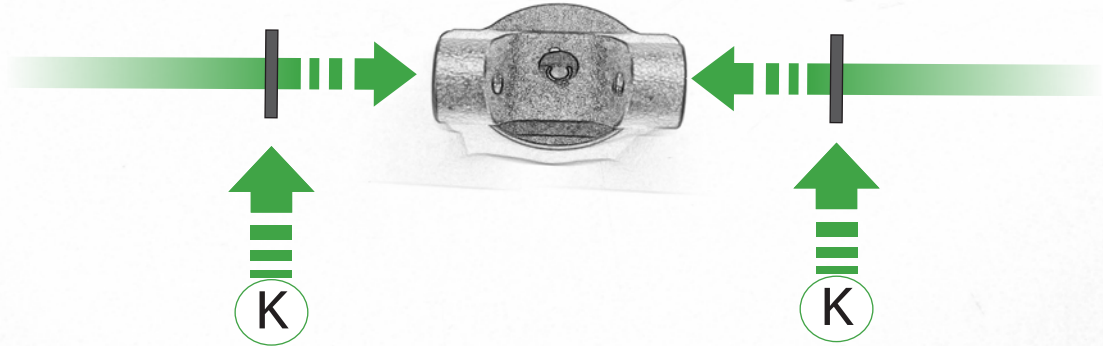

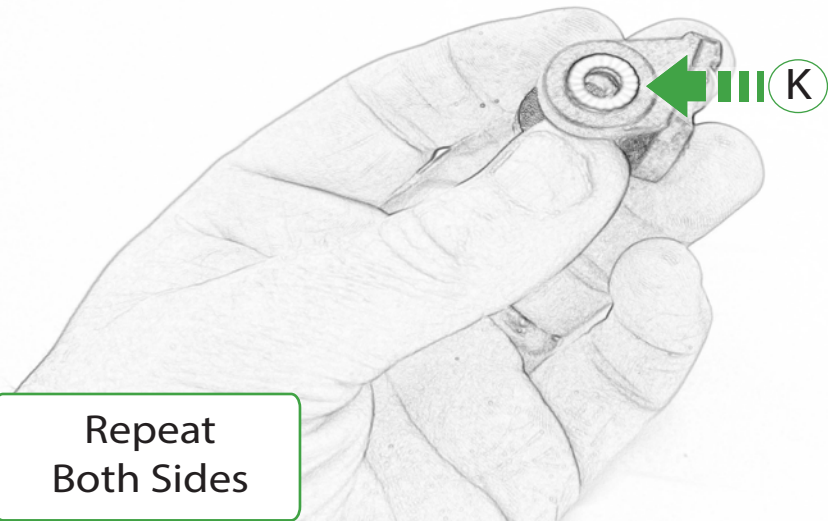

Repeat
Both Sides

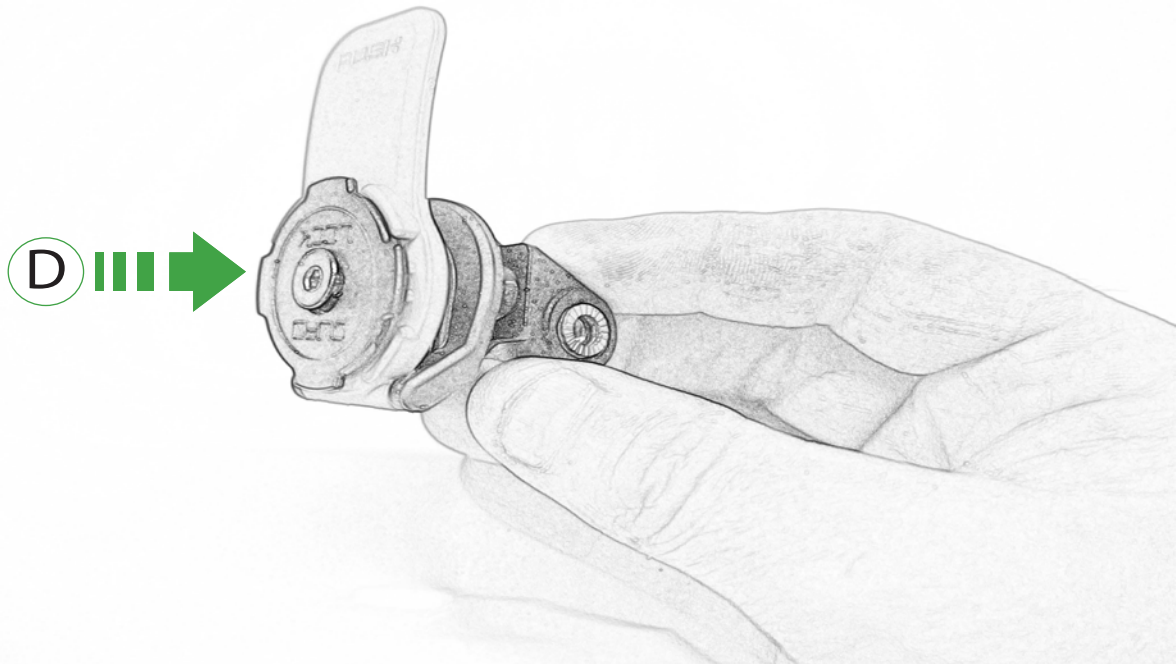

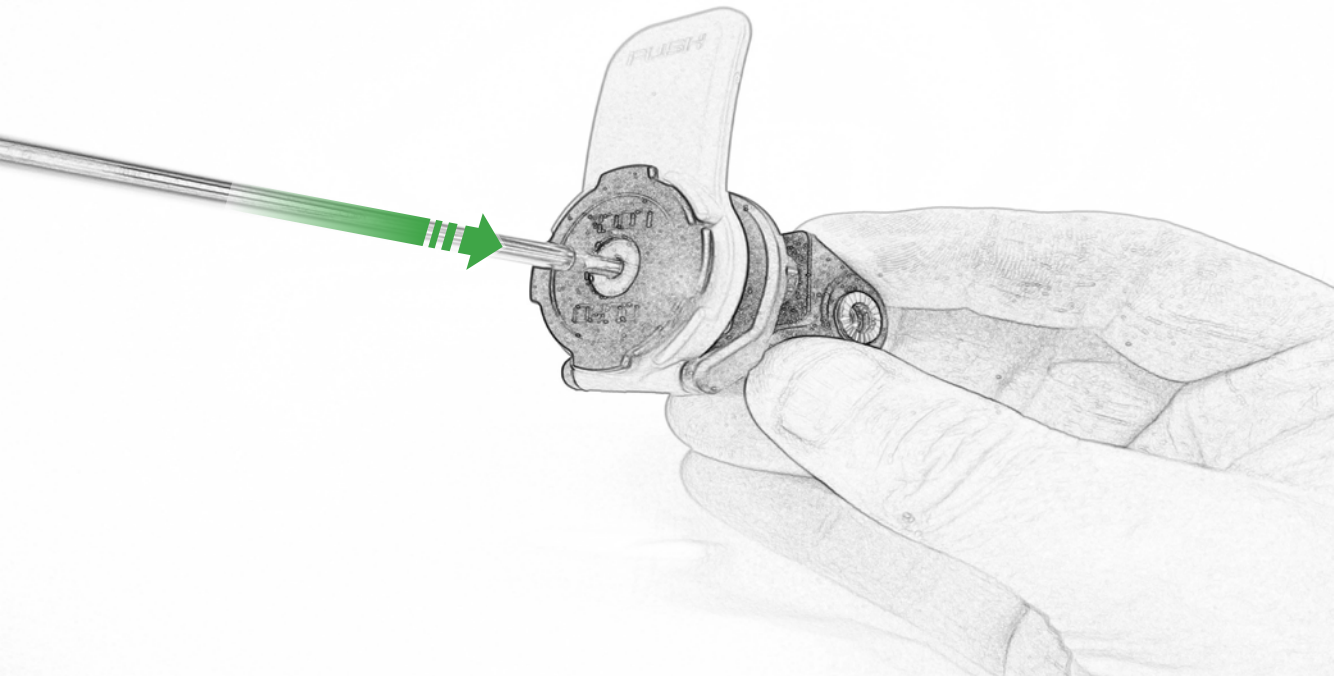

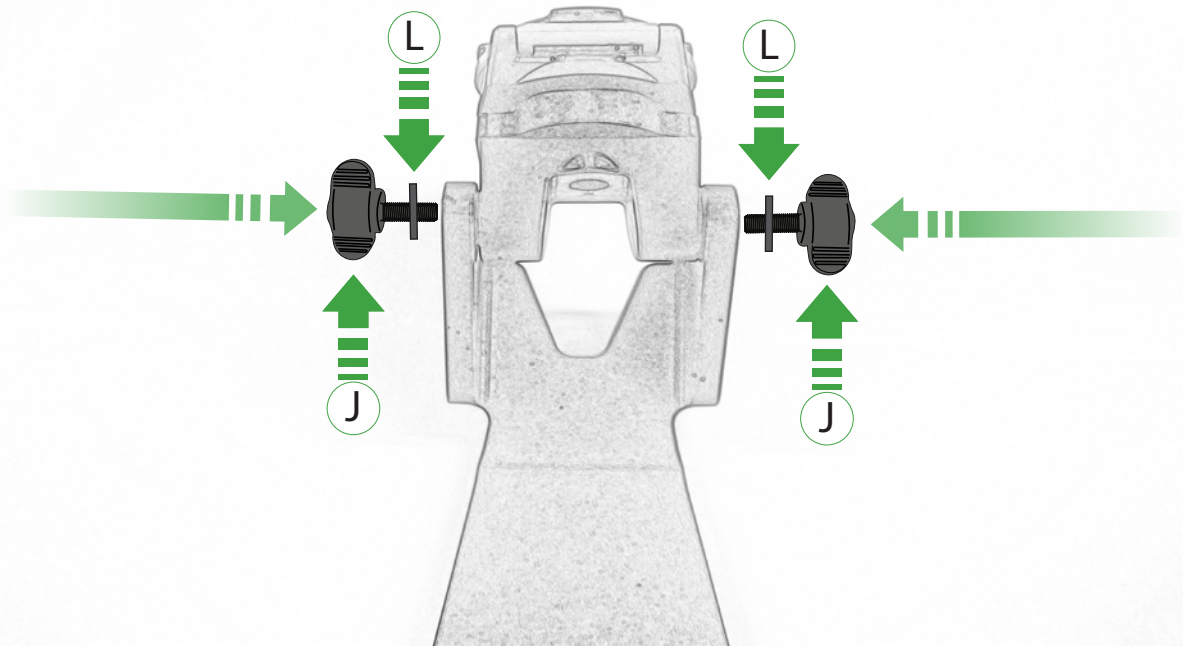



ESSENTIAL CHECKS



It is recommended that periodic inspections are made to ensure that all bolts are tightened to the specified torque settings.

Should the bike be involved in an accident a thorough inspection should be made and any components that have taken an impact, no matter how small, be replaced



EVOTECH®
P E R F O R M A N C E

www.evotech-performance.com