

STEYA208

YAMAHA MT-03 (06-14)

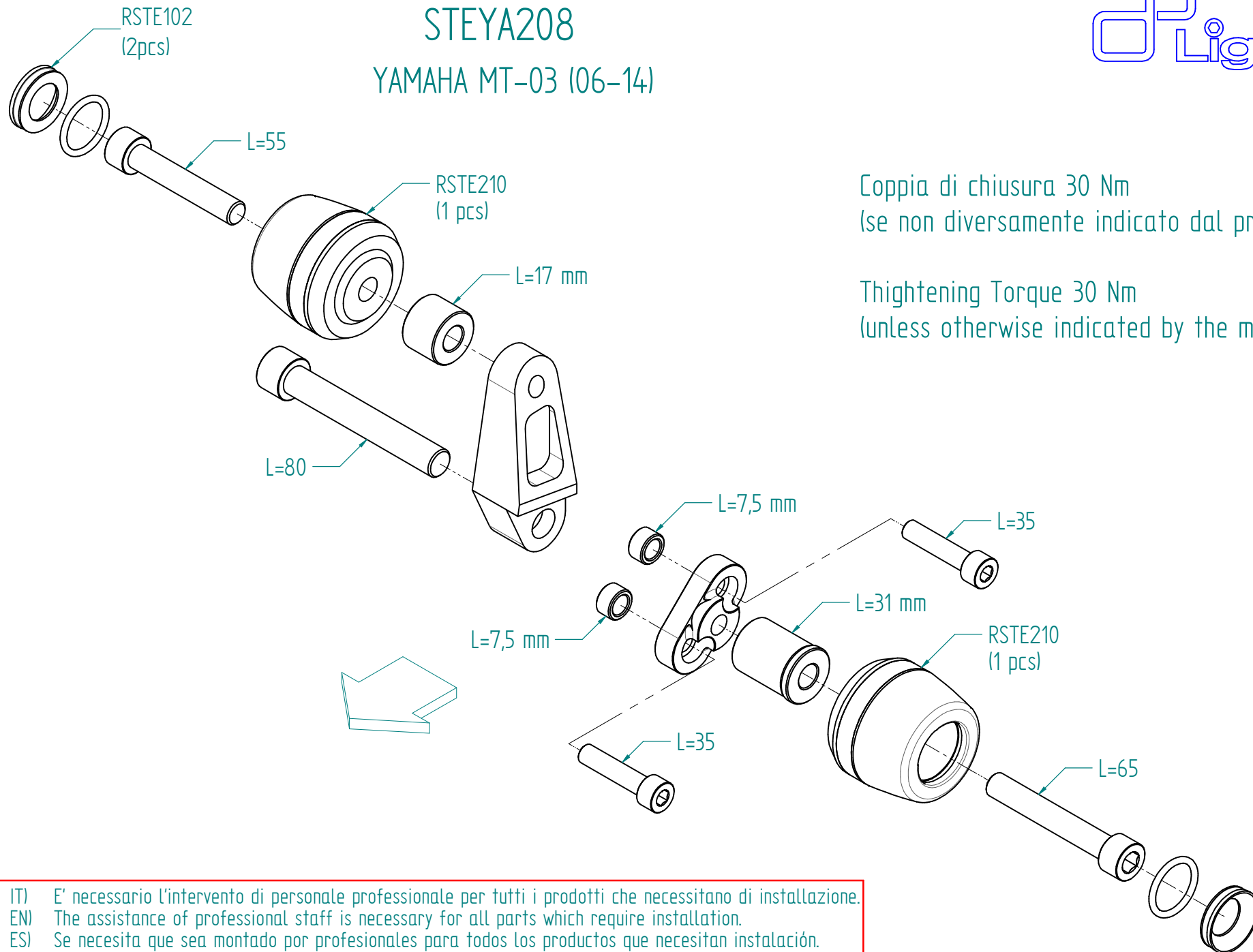

Coppia di chiusura 30 Nm
(se non diversamente indicato dal produttore)

Tightening Torque 30 Nm
(unless otherwise indicated by the manufacturer)



IT) E' necessario l'intervento di personale professionale per tutti i prodotti che necessitano di installazione.
 EN) The assistance of professional staff is necessary for all parts which require installation.
 ES) Se necesita que sea montado por profesionales para todos los productos que necesitan instalación.
 FR) L'assistance d'un professionnel est nécessaire pour toutes les pièces qui nécessitent une installation.
 DEU) Der Eingriff von Fachpersonal ist notwendig für alle Artikel die installiert/montiert werden müssen.

- VERIFICARE SERRAGGIO VITI PRIMA DELL'UTILIZZO / CONTROL THE THIGHTENING'S SCREW BEFORE USING